



KVP-L50US Projector

User Manual

XGA / WXGA / WUXGA

World first **LCD HLD** projector

High **brightness** and **contrast**

Best picture quality

20000 Hours of real life time

360° projection

Unique 0.29 ultra throw lens with **Zoom** and **Focus** function

Lens shift function

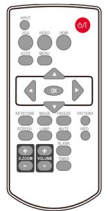
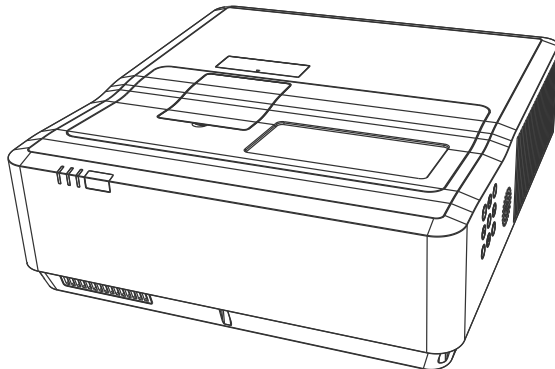

✓ **Note:**

- Before using the product, please read these instructions carefully, and kept safely for future reference.
- OSD options and pictures shown in this document may differ slightly from your product.
- Changes to this manual may be made without notice.

Features and design

Thank you for purchasing the projector. This product is a LCD HLD projector, with ultra short throw lens and new generation light source technology of liquid crystal. high contrast, 5000 lumens,6000 lumens of brightness and up to 20,000 hours of real time, which can keep the brightness diplay throughout the life. Meanwhile, the use of ultra short throw technology can avoid the radiation on the human body and completely eliminate the interference of the shadow on the screen. It is equipped with multimedia feature and use LCD display (LCD) technology with its color depth up to 1.07 billion color. In addition, mute design, the interface location on back of the projector and others make our product with the perfect user experience.

Main features

- 20000H hours of real time with the new light source of HLD+P2W;
- LCD display (LCD) technology: XGA (1024x768),WXGA (1280x800) and WUXGA (1920x1200);
- Unique 0.27 ultra throw lens;
- 360° projection technology;
- Zoom and Focus function;
- Lens shift function;
- Equiped with 10W * 2 speakers;
- Auto setup function;
- Perfect combination of high brightness and color;
- Multi-interface, dual HDMI input;
- Blank design. Tap the button, the projector will switch into blank screen status immediately for prevention of information leakage.
- Various projection mode;
- On and Off instantly;
- 0.5W ultra low power consumption on standby mode;
- Industrial design. ESD filter (static) - double dustproof design and filter check function automatically;
- Logo PIN Code lock and Kensington lock to anti-theft function;
- Closed Caption function;
- Abnormal log management and troubleshooting function;

✓ Note:



- The screen menu and images in the manual may slightly differ from the real product.
- The manual is subject to change without prior notice.

Features and design	2	Color adjust (for PC.).....	44
Content	3	Color adjust(for Video, S-video or component).....	45
Safety operation guideline	4	Setting	46
Safety instruction.....	5	On start.....	46
Chemical substances table.....	6	Standby mode.....	46
Notes.....	7	High land.....	47
Air ventilation.....	9	Light source control.....	47
Place your projector correctly.....	9	Cooling Fast.....	47
Moving your projector.....	10	Closed caption.....	48
Compliance	11	Key lock.....	48
Accessory	12	Contrast optimization.....	49
Name and function of your projector	13	Sound.....	49
Front/top.....	13	HDMI setup.....	50
Rear.....	13	Expand	51
Bottom.....	13	Language.....	51
Terminal.....	14	Auto setup.....	52
Side control panel and indicators.....	15	keystone.....	52
Remote controller.....	16	Logo.....	55
Install battery of remote controller.....	17	Security.....	56
Remote controller operation range.....	17	Power management.....	57
Installation	18	Filter counter.....	58
Project way.....	18	Text pattern.....	58
Screen size.....	18	Factory default.....	58
Adjustment pad.....	19	Network.....	59
Lens shift adjustment.....	20	Memory Viewer	60
Connect to PC.....	21	Set slide.....	60
Connect to video equipment.....	22	Slide transition effect.....	60
Connect to audio equipment.....	23	Sort order.....	60
Connect to USB and wireless card.....	24	Rotate.....	61
Connect the AC power cord.....	25	Best fit.....	61
Basic operation	26	Repeat.....	61
Power on your projector.....	26	Apply.....	61
Power off your projector.....	27	Info	62
How to use the OSD.....	28	Network control	63
Menu item overview.....	29	Useful function	69
Zoom /focus function.....	30	Memory Viewer.....	69
Lens shift function.....	30	USB display function.....	71
Auto setting function.....	31	Maintenance and cleaning	74
Keystone adjustment.....	31	Status light indicator.....	74
Volume adjustment.....	32	Clean casing of your projector.....	75
Menu operation.....	32	Clear the filter.....	75
Remote controller operation.....	33	Reset the filter counter.....	76
Input selection.....	35	Appendix	77
Display	37	Troubleshooting.....	77
Auto PC adj.....	37	Menu tree.....	79
Fine sync.....	37	Light indicator status.....	82
H position.....	37	Compatible computer screen.....	83
V position.....	38	Terminal configuration.....	84
H size.....	38	Dimensions.....	85
Aspect.....	38	Technical specifications.....	86
Project way.....	39	RS232 control mode.....	87
Menu position.....	39	Back cover.....	91
Background display.....	40		
System.....	41		
Color adjust	43		
Image mode.....	43		

Safety operation guideline

Safety instructions



This document and your projector employ certain symbols to illustrate how to use your projector safely. They are described below: Please get yourself familiar with them before going through this document.

 Caution	Ignoring messages indicated by this symbol may lead to personal injuries or deaths due to human errors.
 Note	Ignoring messages indicated by this symbol may lead to personal injuries or property damage.
	High voltage inside with risks of electric shock.

Please read this manual carefully before installing and operating your projector.

Your projector comes with a lot of convenient features and functions. You may make the most of these features and keep your projector in good working conditions by using it correctly. Invalid operation of your projector may not only shorten its life cycle but also may lead to product failure, fire, or other incidents.

In case of any operation abnormality, refer to this manual to check your operation and connections and try solutions given in the “Troubleshooting” section at end of this manual. If the problem persists, call your dealer or our service center.

 <div style="border: 1px solid black; padding: 5px; text-align: center;"><p>Caution</p><p>Danger of electric shock DO NOT open this.</p></div> 
<p>Note: DO NOT remove the casing (or back cover) as this may result in electric shock. Users shall not execute any maintenance work on components within your projector. Call qualified maintenance personnel in case of any maintenance requirements.</p>



High voltage inside with risks of electric shock.



Operation and maintenance tips about these components.

Safety operation Guideline

Notes



Caution

Safety precautions:

- GROUND your projector.
- Lens of your projector projects strong light. DO NOT look at the light beam directly. You may get your eyesight hurt. This is especially the case with children.
- Unplug the AC power plug if your projector will not be used for long time.
- DO NOT overload the socket of power cord as it may lead to fire or electric shock. DO NOT subject the power cord to any object. DO NOT place your projector in locations where its power cord may become damaged by treading by passersby.
- Disconnect the power plug before cleaning your projector. DO NOT apply liquid or sprays to your projector. DO NOT wipe your projector with wet cloth.
- Please follow warnings and instructions given in labels attached to your projector. Unplug your projector when your projector is exposed to thunderstorm weather, is unmanned, or not in use for long periods to prevent damage caused by lightning and power surges.
- DO NOT use accessories without recommendation by the manufacturer as it may result in potential risks.



Caution

Precautions on air outlet:

- Keep adequate clearance around your projector for its ventilation and cooling. See figure below for the least clearance requirements. The least clearance is a MUST when your projector is placed within a cabinet or other closed environment.

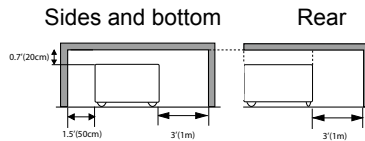

- DO NOT cover the air outlet of your projector. Poor ventilation not only shorten life cycle of your projector but also may lead to risks.
- Slots and openings at rear and bottom of your projector are designed for ventilation. Keep your projector from overheated to ensure its steady operation.
- DO NOT cover the air outlet with cloth or other objects. DO NOT place your projector on the surface of bed, sofa, carpets, or similar object as this may block the air outlets at its bottom.
- DO NOT place your projector in closed environment, e.g. a bookcase, unless it is well ventilated.
- Keep any matter from falling in your projector through the air outlets as they may touch high voltage parts and lead to fire or electric shock by short circuits. DO NOT splash liquid to your projector.



Note:

Precautions on location of your projector:

- Place your projector in a proper location or it may result in fire.
- DO NOT expose your projector in rain or high humidity environments or it may result in fire or electric shock. DO NOT your projector near water or splashing water. DO NOT place any water container, e.g. flower vase, atop your projector.
- DO NOT place your projector in environments of soot, moisture or smoke, e.g. your kitchen, or it may lead to product failure or accidents. Your projector may be damaged by contact with oil or chemicals.
- DO NOT place your projector near exhaust pipe or air conditioning equipment.
- DO NOT place your projector near radiator or heating pipes.
- DO NOT place your projector atop unstable truck, rack, or table. It may fall off the surface and lead to personal injuries and property damages. Please use cart or rack recommended by the manufacturer or included with your product. Please follow steps given in installation guideline included with the wall and ceiling mount racks for installation. Use installation components approved by the manufacturer.
- Be careful when moving your projector with cart. Abrupt stops, pushing too hard and rugged surfaces may topple your projector and the cart together.

FOR EU USERS

The symbol mark and recycling systems described below apply to EU countries and do not apply to countries in other areas of the world.

Your product is designed and manufactured with high quality materials and components which can be recycled and/or reused.

The symbol mark means that electrical and electronic equipment, batteries and accumulators, at their end-of-life, should be disposed of separately from your household waste.

Note:

If a chemical symbol is printed beneath the symbol mark, this chemical symbol means that the battery or accumulator contains a heavy metal at a certain concentration.

This will be indicated as follows: Hg: mercury, Cd: cadmium, Pb: lead In the European

Union there are separate collection systems for used electrical and electronic equipment, batteries and accumulators.

Please, dispose of them correctly at your local community waste collection/recycling centre.

Please help us to conserve the environment we live in!



Caution:

Contains mercury

For more information on safe handling procedures, the measures to be taken in case of accidental breakage and safe disposal options visit: ec.gc.ca/mercure-mercury/

Dispose of or recycle in accordance with applicable laws.

Safety operation Guideline



Note:

Precautions on using your projector:

- DO NOT project the same image for long time as residual images may be left in the panel. This is a property of LCD panel.
- Use power as indicated in tags attached to your projector. If you have doubts over available power type, consult your dealer or local power company first.
- DO NOT open or remove the casing for maintenance as this may lead to electric shock or other damages. Call qualified maintenance personnel in case of any maintenance requirements.
 - In case of the following, unplug the power cord and call qualified maintenance personnel for service immediately:
 - a. Damaged or broken power cord or plug
 - b. Liquid splashed in your projector
 - c. Your projector exposed to rain or water
 - d. If your projector fails to work as expected by following operation instructions, adjust it according to given instructions. Other invalid operations may damage your projector, which requires the technician to spend more time before returning it back to normal.
 - e. The projector falls off to ground or its casing is damaged.
 - f. In case of any abnormal change in your projector during its use, then maintenance services would be required.
- In case components replacement is required, make sure the replacements have been approved by the manufacturer and features the same with the one being replaced. Use of unauthorized parts may lead to fire, electric shock or personal injury.
- After the completion of maintenance or repair work, get the maintenance personnel to run routine safety check to ensure your projector's safety operation status.

Information for users in the European Union

This is a device to project images onto a screen, etc., and is not intended for use as indoor lighting in a domestic environment. Directive 2009/125/EC.

NOTE FOR CUSTOMERS IN THE US

 LAMP(S) INSIDE THIS PRODUCT CONTAIN MERCURY AND MUST BE RECYCLED OR DISPOSED OF ACCORDING TO LOCAL STATE OR FEDERAL LAWS.

Air ventilation

Openings in the casing are designed for ventilation and overheating prevention. DO NOT block or cover these openings to keep your projector in normal operation and from overheating.



Note:

Heat exhaust at the air outlet Keep the following in mind when using or installing your projector:

- DO NOT place flammable materials or sprayers near your projector.
- Keep the air outlet one meter away from other objects.
- DO NOT touch the area close to the air outlet especially the metal components, e.g. screws. This area and parts will get very hot once your projector starts operating.
- DO NOT place any object atop your projector. They may not only be damaged but also lead to fire after being overheated.

Cooling fans are designed for cooling your projector. Fan speed is auto adjusted subject to internal temperature of your projector.

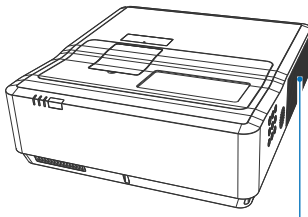

Air outlet
(For heat exhaust)

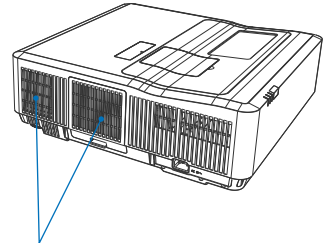

Air intake

Place your projector correctly

Use your projector at specified location in correct way. Invalid location may shorten life-cycle of HLD lights or even lead to severe incidents or fire.

- Enable the “Ceiling” function if flip over screen is required. The projector supports

The projector supports 360° projection in Vertical.

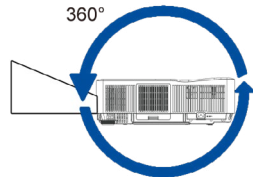

Note:

Precautions on ceiling mount racket installation:

- Get qualified technician to install the ceiling mount racket.
- Warranty of your projector does not cover hazards and damage caused by using ceiling mount rackets provided by unauthorized dealers.
- Remove the ceiling mount racket when it is not in use.
- Apply torque driver instead of power driver or impact driver in your projector.

Safety operation Guideline

Moving your projector

When moving your projector, close its adjustment legs as they may damage the lens and casing. Keep your projector in suitable box when it is not to be used for a long time.



Note:

Precautions on moving or shipping your projector:

- DO NOT drop or impact your projector as it may get damaged or failed in operation.
- Please employ proper container for movement.
- Prohibit express or other shipping service provider personnel from shipping your projector with improper boxes. Your projector may become damaged. Please consult your dealers for shipping your projector by express or other shipping service providers.
- Place your projector in box only after it has been fully cooled down.

FCC Caution

Note: This equipment has been tested and found to comply with the limits for a Class B digital device, pursuant to Part 15 of the FCC Rules. These limits are designed to provide reasonable protection against harmful interference in a residential installation. This equipment generates, uses, and can radiate radio frequency energy, and if not installed and used in accordance with the instructions, may cause harmful interference to radio communications. However, there is no guarantee that interference will not occur in a particular installation. If this equipment does cause harmful interference to radio or television reception, which can be determined by turning the equipment off and on, the user is encouraged to try to correct the interference by one or more of the following measures:

- **Reorient or relocate the receiving antenna.**
- **Increase the separation between the equipment and receiver.**
- **Connect the equipment into an outlet on a circuit different from that to which the receiver is connected.**
- **Consult the dealer or an experienced radio/TV technician for help.**

Use of shielded cable is required to comply with class B limits in Subpart B of Part 15 of FCC Rules.

Do not make any changes or modifications to the equipment unless otherwise specified in the instructions. If such changes or modifications should be made, you could be required to stop operation of the equipment.

THE SOCKET-OUTLET SHOULD BE INSTALLED NEAR THE EQUIPMENT AND EASILY ACCESSIBLE.

Accessory

Accessory for Citrine XGA /WXGA /WUXGA series as follows:

The projector includes such following accessories. Please check all the packaging. If any items are missing, please contact your dealer immediately.

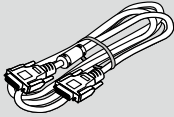

VGA Cable



Note: The AC Power Cord specification depends on the location of your projector.

AC Power Cord

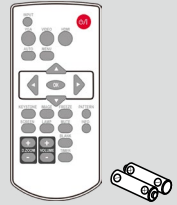

Remote control(AAA*2)

Name and function of your projector

Front/Top

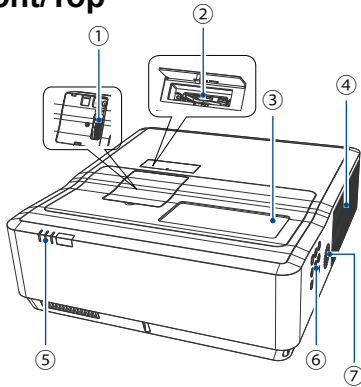

- ① Focus ring
- ② Zoom ring
- ③ Projection lens
- ④ Air exhaust
- ⑤ LED light indicator
- ⑥ Side control panel
- ⑦ Speaker (*2)

Bottom

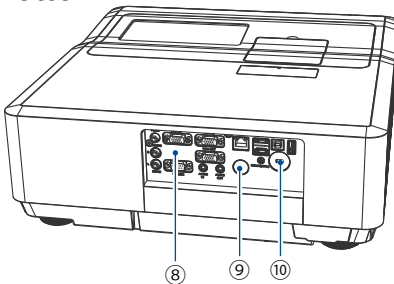

- ⑧ Terminal
- ⑨ Remote receiver (back)
- ⑩ Anti-theft lock

Rear

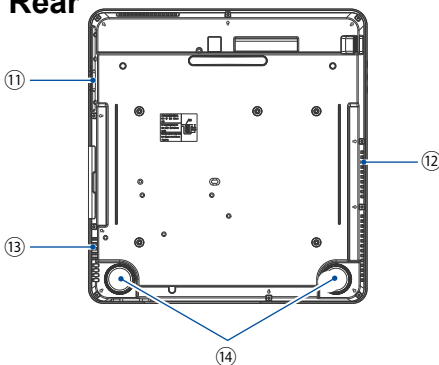

- ⑪ AC Power Cord port
- ⑫ Air exhaust
- ⑬ Air intake
- ⑭ Adjustment pad



Do not place your hands or other objects near the vent:

- Vent will shed heat. Do not put your hands or face, or thermolabile objects placed near the outlet. You need keep at least a distance of 3" (1m) away, or it may cause it burning or damage.

Name and function of your projector

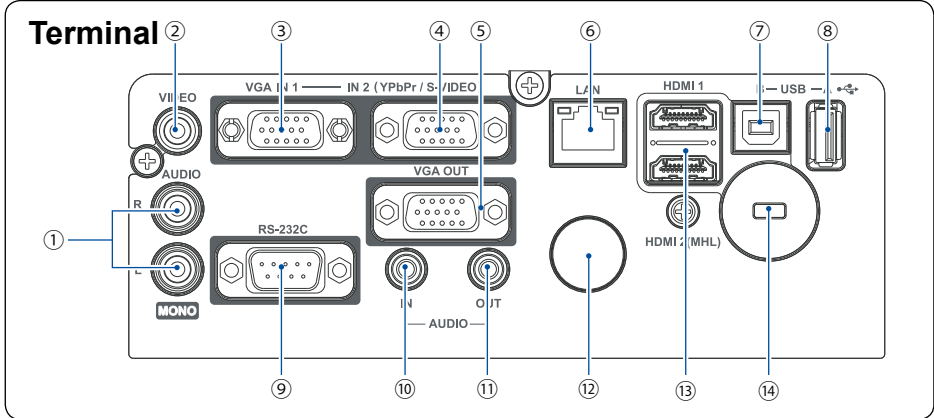

① MONO(L/R) terminal

A mono audio signal (A single audio terminal) should be connected to the mOnO (R / L) interface.

② VIDEO terminal

Connect video output signal to this terminal

③ VIDEO IN1 terminal

Connect output signal from computer to this terminal.

④ VGA IN 2 (YPbPr/S-VIDEO) terminal

Connect the output signal from RGB, YPbPr and S-VIDEO to this terminal.

⑤ VGA OUT terminal

For monitor output, output the signal from ③ or ④ to other monitors

⑥ LAN terminal

Connect mesh cable to this terminal when using network control and operate your projector.

⑦ USB-B connector

When using the "USB display" function, connect your computer to this terminal via the USB cable.

⑧ USB-A connector

When using the Memory Viewer function, insert the USB memory directly to this terminal.

⑨ RS-232C terminal

When using the RS232 functional to operate the projector, connect the serial communication to this terminal.

⑩ AUDIO IN terminal

Connect audio signal of the PC to this terminal.

⑪ AUDIO OUT terminal

Connect external audio devices to this terminal.

⑫ Remote Receiver (rear)

Use the remote control to operate the projector.

⑬ HDMI 1/HDMI 2(MHL) connector

Connect HDMI1 digital output signals or HDMI 2(MHL) digital output signals to this terminal.

⑭ Anti-theft slot

Use such function to help users to deter theft of the projector.

Side control panel and indicators

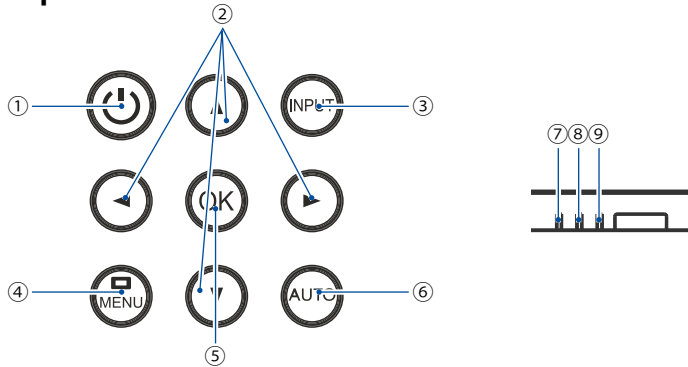

① POWER

Open or close the projector.

② Arrow ▲ ▼ ◀ ▶ /UP/DOWN/VOL-/VOL+

- Select items or adjust the data in the OSD menu.
- Adjust the volume.

③ INPUT

Open or close the INPUT menu.

④ MENU

Open or close the OSD menu.

⑤ OK

- Enter the OSD menu
- Select options in the OSD menu .

⑥ AUTO

Perform AUTO Setup, including "Source Search" and "Auto PC Adjust."

⑦ POWER indicator

- The power indicator turns steady red when your projector is in standby mode.
- It turns steady green when your projector is in normal operation.
- It flashes green when your projector is in power control mode(standby) mode.

⑧ STATUS indicator

It flashes red when internal temperature of your projector is out of operation range.

⑨ FILTER indicator

It turns red when the filter needs be replaced.

Name and function of your projector

Remote controller

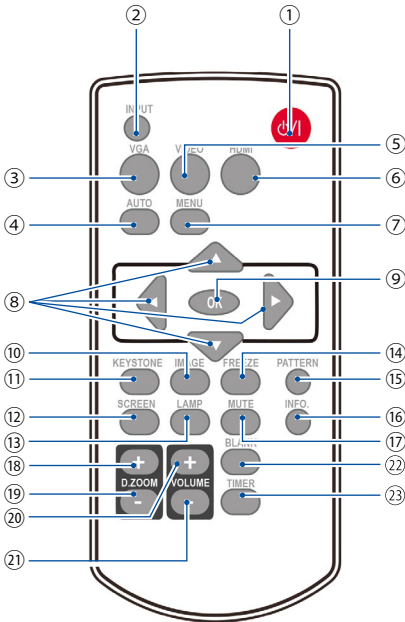

1 **POWER**

Power on or off your projector .

2 **INPUT**

Open or close the INPUT menu .

3 **VGA**

Select VGA/ VGA2/ Component input source.

4 **AUTO**

Enter auto adjustment mode .

5 **VIDEO**

Select VIDEO/ S-VIDEO input source .

6 **HDMI**

Select HDMI 1/HDMI 2(MHL) input source.

7 **MENU**

Open or close the OSD menu .

8 **Arrow**

- Select items or adjust data in the OSD menu .
- Select display area in digital zoom +/- mode .

9 **OK**

Enter the OSD menu or select options in it .

10 **IMAGE**

Select image mode .

11 **KEYSTONE**

Keystone calibration .

12 **SCREEN**

Enter the screen size adjustment menu.

13 **LAMP**

Select LAMP mode.

14 **FREEZE**

Freeze projected images.

15 **PATTERN**

Select built-in test pattern of your projector.

16 **INFO.**

Display current status info. of your projector .

17 **MUTE**

Turn off the sound Temporarily.

18 **D.ZOOM +**

Zoom in projected image .

19 **D.ZOOM -**

Zoom out projected image .

20 **VOLUME +**

Increase volume.

21 **VOLUME -**

Decrease volume .

22 **BLANK**

Dark out screen images temporarily.

23 **TIMER**

Enable the timer function .



PATTERN button on the remote controller is invalid when you choose USB display, Memory viewer and Network as input signal.

Install battery of remote controller

1 Open the battery cover.



2 Insert a new battery in it.



Two AAA batteries

Place batteries with its anode and cathode (+ and -) in correct direction. Keep both poles in good connection to the contacts within the compartment.

3 Put the cover back.



Please follow the following rules for safety operation:



- Use two of AAA batteries.
- Replace both batteries at the same time.
- Do not mix new and old batteries as one pair.
- Keep your remote controller away from water or other liquids.
- Do not expose your remote controller to environments with high humidity or temperature.
- Do not drop your remote controller.
- In case of any battery solution leaking in the compartment, clear it thoroughly before placing new batteries in it.
- Using battery of other types than what specified on this manual may lead to risks of explosion.
- Please dispose your old battery by following instructions given in tag of the battery or local regulations.

Remote controller operation range

Point your remote controller to the IR receiver of your projector.

Maximum operation range of your remote controller is about arc 15° and with about an area of radius 6 meters or about 8 meters in straight line.

Operation range(Left /Right)

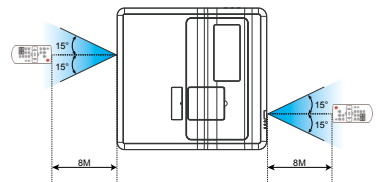

Operation range(Up /Down)

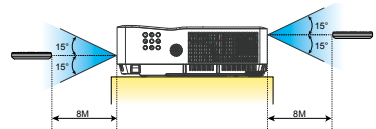

Installation

Project way

The projector supports the following project ways: Front, Rear, Ceiling / Front, Ceiling / Rear, Auto ceiling / Front , Auto ceiling / Rear.

Install the projector according to the installation location. Please turn off the projector when changing the project way. The default projection mode is set to Auto Ceiling / Front, and you can switch to other projection mode from the menu options.

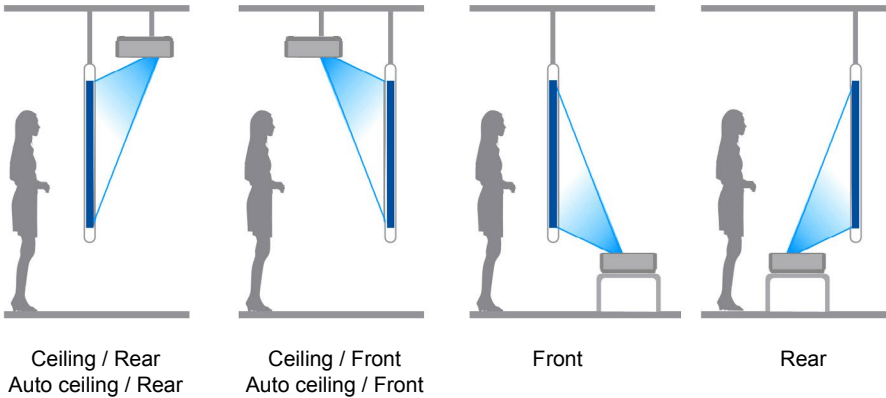

Screen size

- Ambient brightness may affect your projection image quality. For the optimal image effect, it is recommended to control brightness in your environment.
- Values shown in figure below are approximates only. They may differ from the actual ones.
- The further the projector is away from the screen, the larger the projection size will be.
- Use the following table to install the projector in the best position from the screen. The values provided are for reference only.

XGA Series

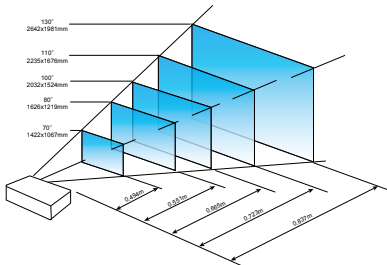

WXGA/ WUXGA Series

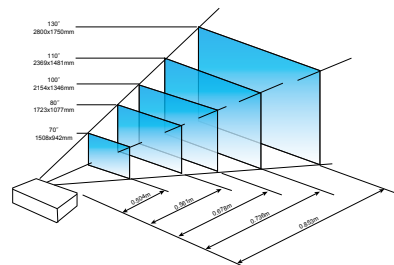

XGA Series

Screen size (WxH)m 4:3 aspect	70"	80"	100"	110"	130"
Wide	0.494m	0.551m	0.665m	0.723m	0.837m
Tel	0.506m	0.565m	0.683m	0.742m	0.860m

WXGA/ WUXGA series

Screen size (WxH)m 16:10 aspect	70"	80"	100"	110"	130"
Wide	0.504m	0.561m	0.678m	0.736m	0.853m
Tel	0.525m	0.586m	0.708m	0.770m	0.892m

Adjustment pad

Place the projector properly so that it is vertical to the screen.

You may use the adjustment leg to raise your projector up to 4.0 degree.

Turn the pad to tilt your projector to required height. To raise your projector, turn both pads clockwise.

To lower down your projector or close the pad, turn both pads counterclockwise.

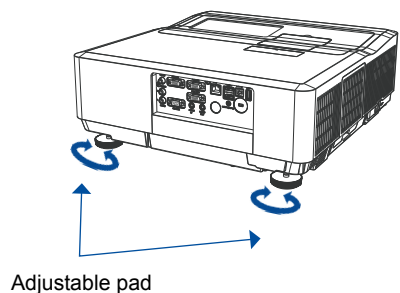
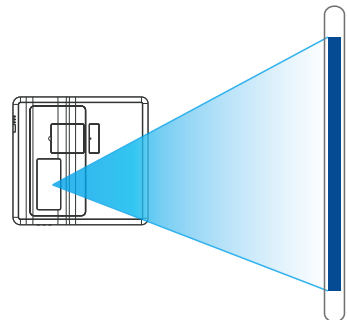

Installation

Lens shift adjustment

The electric lens shift function may adjust your lens in all four directions. This function enables easy image position adjustment.

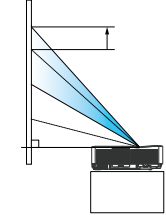
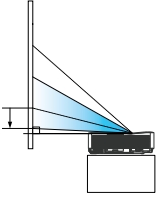
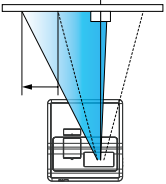
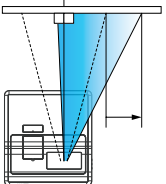
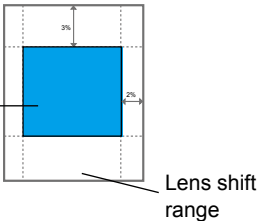
<p>The projection location of your image may be moved upward a distance up to 3% (XGA / WXGA / WUXGA) between the upper and lower range of the image.</p>	<p>Move lens to it top position</p> 
<p>The projection location of your image may be moved downward a distance up to 3% (XGA / WXGA / WUXGA) between the upper and lower range of the image.</p>	<p>Move lens to it bottom position</p> 
<p>The projection location of your image may be moved leftward a distance up to 2% (XGA / WXGA/ WUXGA) of the width of the image.</p>	<p>Move lens to it leftmost position</p> 
<p>The projection location of your image may be moved rightward a distance up to 2% (XGA / WXGA/ WUXGA) of the width of the image.</p>	<p>Move lens to it rightmost position</p> 
<p>Scope of lens shift adjustment (when the Lens move to the limit, the screen will be dark or shadow)</p>	<p>Center the lens</p>  <p>Lens shift range</p>

* This table is measured with standard lens.

* When the setting of LENS SHIFT as the maximum position, the corner of projection image might be darker.

Connect to PC (Digital and Analog RGB)

Cables for connection:

- VGA cable
- HDMI cable*
- Serial cable (Cross type)*
- HDMI cable*

(* This cable is not included.)

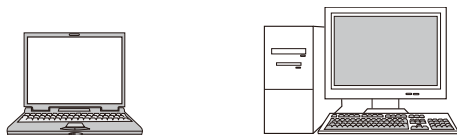

RS232 Output

VGA Signal Output

VGA Signal Input

HDMI Digital
Signal Output

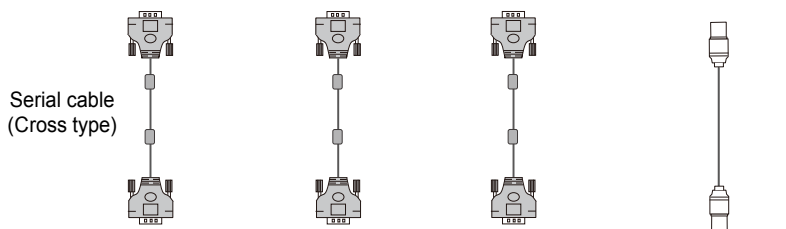

RS232 Input

VGA Signal Input

VGA Signal Output

HDMI Digital
Signal Input

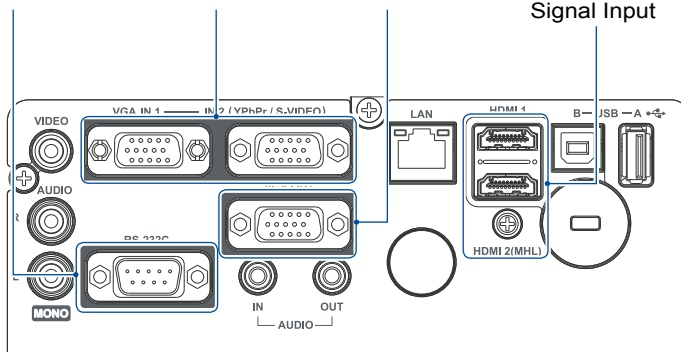

Unplug power cords of your projector and all external equipment before connecting any cable to them.

Installation

Connect to video equipment

Cables for connection:

- S-VIDEO cable**
- Component cable**

(**Dedicated cable is available to your dealer .)

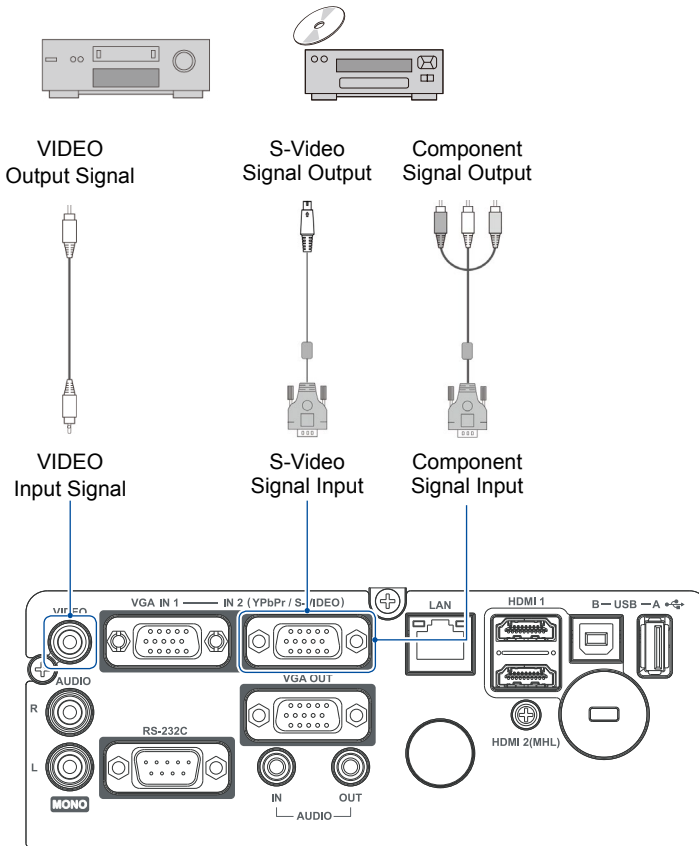

Unplug power cords of your projector and all external equipment before connecting any cable to them.

Connect to audio equipment

Cables for connection:

- Audio cable*

(* This cable is not included.)

External audio devices

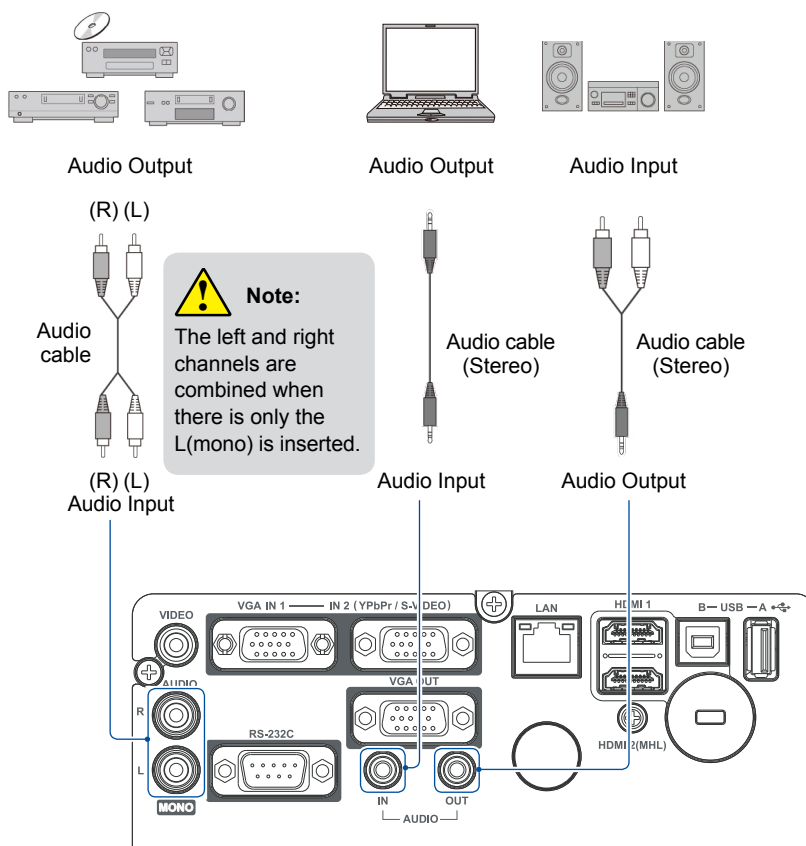

Unplug power cords of your projector and all external equipment before connecting any cable to them.

Installation

Connect to USB and Wireless card (USB-A and USB-B)

Cables for connection:

- USB-A or USB-B cable*

(* This cable is not included.)

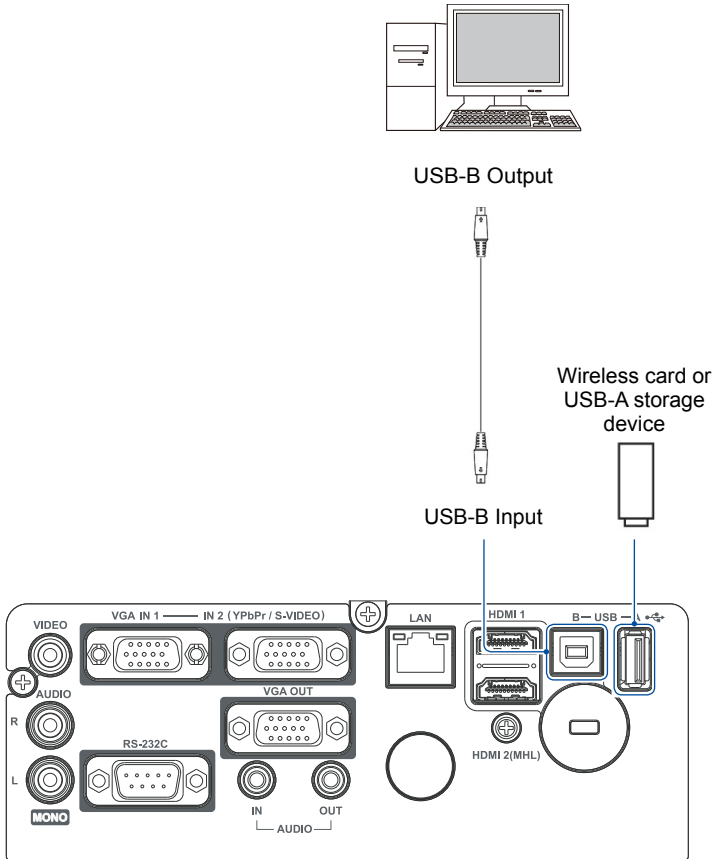

Unplug power cords of your projector and all external equipment before connecting any cable to them.

Connect the AC power cord

Standard voltage employed by your projector is AC 100-240V. It adapts to different input voltage automatically. Your projector employs single-phase power cord with neutral ground cable.

DO NOT use any other type of power cords or you may face the risks of electric shock. In case you have any doubt on type of power cord you are using, please call authorized dealer or service center for help. Before powering on your projector, get all external equipment connected in advance.



Note:

Keep your AC power socket close to your projector for easy plugging and unplugging.

✓ **Note:**

For safety reasons, unplug the AC power cord when your projector is not in use. Your projector will consume a small amount of power when it is connected to AC grid power and in standby mode.

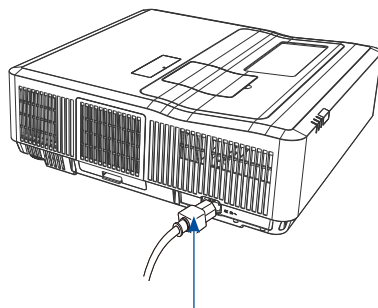

Connect included AC power cord to your projector.

Precautions on power cord

Your AC power cord should meet regulations of the country/district where your projector is used.

Please make sure the type of the power plug is compliant with those given in figure below. Make sure you are using a valid AC power cord.

In case the included AC power cord does not comply with the AC power socket in your location, call your dealer for replacement.

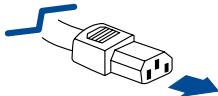
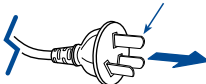
The projector side	Connect to the AC power socket
 <p data-bbox="165 1209 508 1257">Connect to power cord connector of your projector</p>	<p data-bbox="804 1082 947 1104">Grounding end</p>  <p data-bbox="640 1219 911 1241">Connect to AC power socket</p>

✓ **Note:**

- Use of invalid power cord may hamper product performance or even lead to electric shock, fire, and other incidents. Please use power cord compliant with the included one to ensure product performance and operation safety.
- The frequently used cables are: AC power cord, VGA cable, audio cable, video cable, and serial control cable.

Basic operation

Power on your projector

1. Connect all external equipment to your projector (e.g. computer or camera) before powering it on.
2. Connect AC power cord of your projector to an AC power socket. The Power indicator turns on in red.
3. Press the Power button on the top control panel or the remote controller.
The Power indicator lights in green and the cooling fan starts running.
4. If your projector is setting as password protected, the password dialog box displays. Enter your password as instructed below.

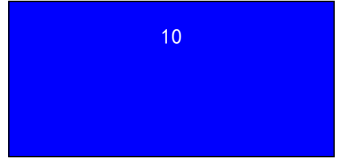

✓ **Note:**

- In case the "Logo Select" option is set to OFF, then no welcome image will display in screen.
- You can do nothing but powering off your projector during the welcome image is displaying.

Enter password (PIN)

Press ▲▼ button to select a number, press ► button to enter it and move the cursor. The number you typed is displayed as "*"". To edit number you have entered, press ◀ button to move the cursor to the number you want to change, press ▲▼ button to select the correct one.

Repeat this step to type in a 3-digit number.

Move the cursor to SET after you have typed the 3-digit number. Press the OK button and now you are ready to use your projector.

If the password is invalid, the password displayed as "***" will be in red. Please try again with a valid one.

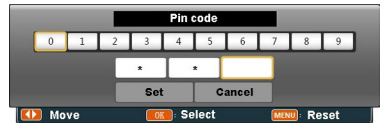
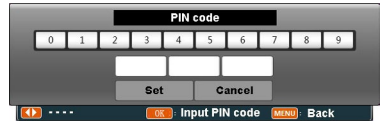

Move the cursor to Set button, then press the OK button.



What is a password (PIN)?

A password (PIN) is an ID code for identifying people with knowledge about it to operate your projector. A password (PIN) setting may help preventing your projector from unauthorized use.

Your password (PIN) code is a 3-digit number. To find out more about protecting your projector with a password (PIN), please refer to the PIN Code Lock function in the Setup menu on Page 54 for details.

Precautions on password (PIN) operation

You cannot operate a password (PIN) protected projector without correct password (PIN). Please set up a new password (PIN) and keep your operation manual in safe place. In case the password (PIN) is lost or forgotten, call your dealer or service center.

Power off your projector

1. Press the Power button at the side control panel or the remote controller, the “Power off?” message displays.
2. Press the Power button again in 4 seconds after the “Power off?” message prompted to you. The POWER indicator flashes red while the cooling fan continues running. (You may set up noise level and speed of the fan when it is cooling down.) Unplug the power cord until the fan stops running. Failure to do so may shorten life cycle of your projector or lead to power on failures or operation abnormalities.

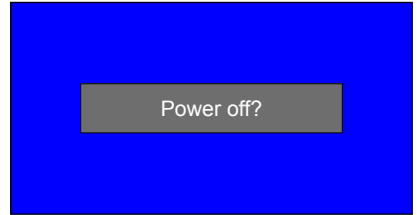

“Power off?” message disappears in 4 seconds.



To maintain the life cycle of the HLD light, power off your projector after it has been turn on for at least five minutes.

Do not use your projector without stops. As it may hurt the life cycle of your HLD light source. Power off your projector at least once every 24 hours and have it idle for an hour.

✓ **Note:**

- If the “On Start” function is set to “On”, your projector will power on once it is connected to an AC power socket. (Refer to page 46)
- Speed of the cooling fan varies with internal temperature of your projector.
- Do not place your projector in any box before it is fully cooled down.
- In case the POWER indicator flashes or turns red, refer to the “Status light indicator ” for instructions. (Refer to page 82)
- The POWER indicator flashes when the lamp is cooling down. Do not power on your projector at this time. Power on your projector only after the POWER indicator turns red.
- Unplug the power cord after your projector has been turned off. The fan stops running.

Basic operation

How to operate the OSD

You can adjust or set up the projector on the on-screen menu .

The menu has a multilayer structure. Each main menu is divided into several sub-level menus, then each submenu is divided into several submenus.

Please refer to the appropriate section of this manual for the procedure for the adjustment and settings.

Rear control panel

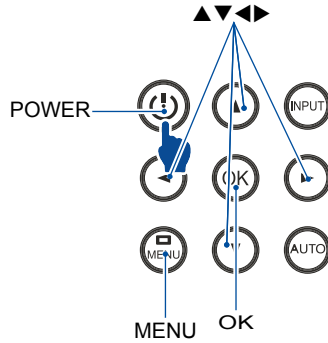

Remote controller

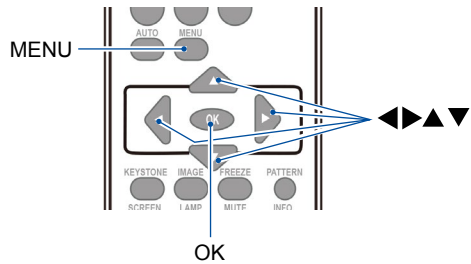

1. Press the MENU button on the side control panel or remote controller and the OSD displays.
2. Press ▲▼ button to act on or select one mainmenu item. Press ► button or OK button to enter a submenu.
3. Press ▲▼ button to select required sub-menu, then press OK button or ► button to set up or enter an option.
4. Press ▲▼ button to select settings or navigate options, then press OK button to act on the item and exit.
5. Press ◀ button to return to mainmenu. Press the MENU button on remote controller or control panel to exit the OSD.

OSD Menu

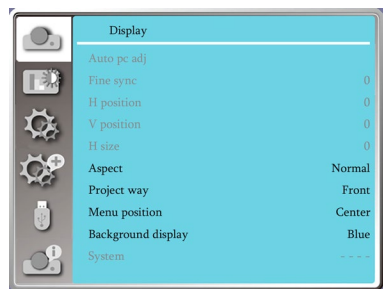

Menu item overview

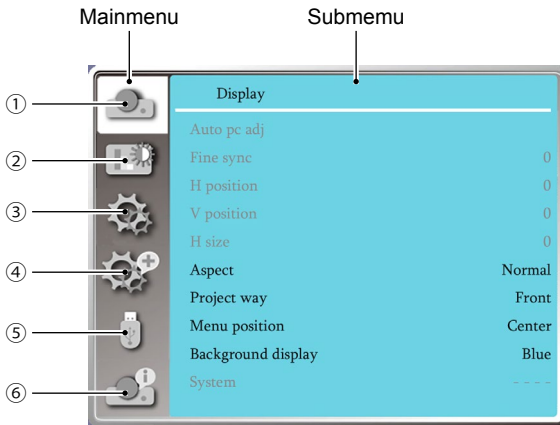

① Display menu

- Select Auto PC adj., Fine sync, H Position, V Position, H. size to adjust the parameters to match the VGA format.
- Aspect : Normal, Wide, Full.
- Project way: Choose Front, Rear, Ceiling / Front, Ceiling / Rear, Auto ceiling/Front and Auto ceiling/Rear .
- Menu position: Set screen menu display position on the screen.
- Background display: Sets the background color of the projection screen with no signal input.
- System: Select the compatible system signal format with input source .

② Color adjust menu

Available options in the Image Select menu are Dynamic, Normal, Cinema, Blackboard (Green), Colorboard, or User Image.

- For AV signal input ,the available color adjust options : Contrast, Brightness, Color, Tint, White balance(Red, Green, Blue) and Sharpness.
- For PC signal input ,the available color adjust options :Contrast, Brightness, Color temp. , White balance(Red, Green, Blue) and Sharpness.

③ Setting menu

Configuration of the basic function operation on the projector: On start, Standby mode, High land, Light source control, Cooling fast , Closed caption, Key lock, Contrast optimization, Sound and HDMI Setup.

④ Expand menu

Available adjust options are Language, Auto Setup, Keystone, LOGO , Security, Power management, Filter counter, Test pattern, Network, Factory default and Lamp counter.

⑤ Memory Viewer menu

Select parameter Of Set slide, Slide transition effect, Sort order, Rotate, Best fit,Repeat,Apply .

⑥ Information menu

Display information about the projector.

Basic operation

Zoom /Focus function

Rotate the ZOOM ring to zoom in or out. Right rotate the ring may magnify the image, while it may zoom out the image in the opposite direction. (See Figure one for detail)

Rotate the FOCUS ring to adjust the focal length of the image. (See Figure two for detail)

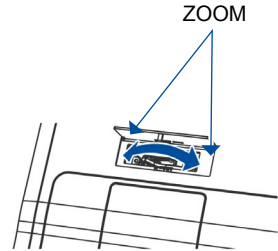

(Figure one)

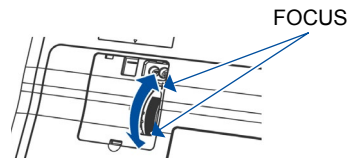

(Figure two)

Lens shift function

Press the H/V button to make Lens shift adjustment manually.

Use a screwdriver to rotate the V screw, then you can move upward and downward the image with a distance up to 3% (XGA/ WXGA/ WUXGA) between the upper and lower range of the image. (See Figure three for detail)

Use a screwdriver to rotate the H screw, then you can move rightward and leftward the image with a distance up to 2% (XGA/ WXGA/ WUXGA) of the width of the image. (See Figure four for detail)

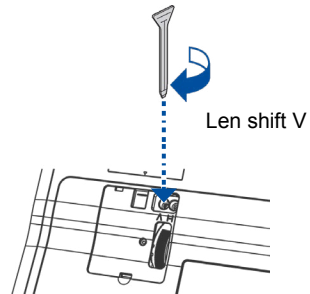

(Figure three)

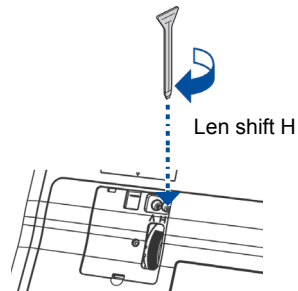

(Figure four)

Auto setting function

Press the AUTO button on the side control panel or your remote controller to auto execute settings given in the Auto Setup on the Expand menu (including Input search and Auto PC adj.).

Top Control Panel

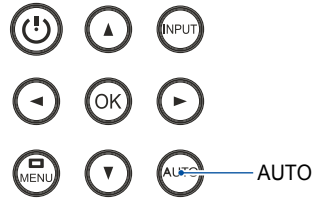

Remote controller

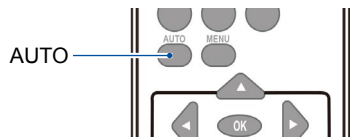

Keystone adjustment

You may adjust keystone distortion of image in your projector with the V keystone adjustment. Follow steps below to adjust keystone distortion of projected image manually.

- Curved correction function only for Citrine XGA and Citrine WXGA.

Press the KEYSTONE button on your remote controller. The keystone adjustment dialog box displays (including H/V Keystone, Corner correction, Curved correction, Reset value) , press ▲▼◀▶ button to adjust keystone distortion.

You may save your settings for keystone adjustment.

H/V Keystone.....Adjust the projected image when the projector is on the horizontal or vertical keystone distortion.

Corner correction.....Adjust the projected image when the projector is keystone distortion of four corners .

Curved correction.....Adjust the projected image when the projector linearity is uneven or the projected images bent vertically and horizontally.

Reset value.....The correction values will be restored to the factory defaults.

Remote controller

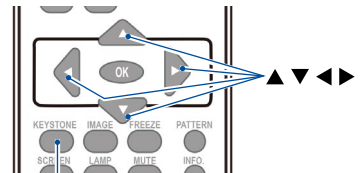

KEYSTONE

H/V Keystone

Corner correction

Curved correction

Reset value

Basic operation

✓ **Note:**

- The arrow mark looks white when there is no keystone adjustment in existence.
- The arrow mark indicating the adjustment direction turns red.
- The arrow mark disappears when the maximum adjustment limit reaches.
- The keystone prompt box will disappear if you press the KEYSTONE button again when it is displaying. Press the OK button again to switch the four correction items.
- The adjustable range is subject to source of signal input.
- For further details about Keystone function, please turn to page 52-54.

Volume adjustment

You'd better use the remote control to complete directly.

Volume

Press the remote control Volume +/- buttons to adjust the volume.

MUTE

Press the mute button on the remote control to select "ON", you can temporarily turn off the sound. Press the mute button again to select "Off" or press the volume +/- keys to re-open the audio effects.

Mute function is also effective for audio output interfaces.

Remote controller

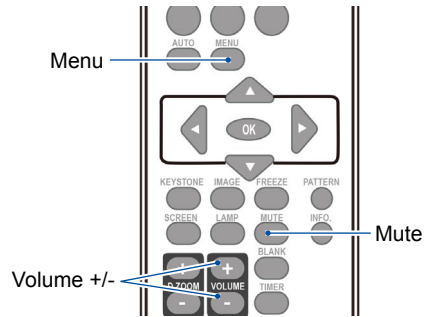

Menu operation

1. Press the MENU button on the side control panel or remote controller and the OSD displays. Press ▲▼ button to enter setting menu, then press OK or ► button.
2. Press ▲▼ button to select sound, press OK or ► button to enter.
3. Press ▲▼ button to select volume or mute.
Volume.....Press ▲ button to increase volume.
Press ▼ button to decrease volume.
Mute.....Press ▲▼ button to switch to On or Off .
4. Press OK button to select.

Sound menu

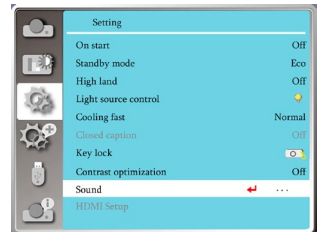
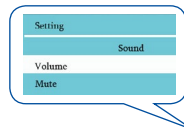

Remote controller operation

Use your remote controller for common operations.

Freeze (FREEZE)

Press the FREEZE button on remote controller to freeze image and mute the audio. Freeze icon appears on the screen. Press the FREEZE button or any button to cancel the freeze function, then the image replay and the sound is restored.

Mute (MUTE)

Press the mute button on the remote control to turn off the sound. To remove the mute function, please press the mute button or volume +/- button to cancel the mute function.

Volume +/- (VOLUME +/-)



press the Volume +/- on remote controller to increase or decrease volume.

Image (IMAGE)

Press the IMAGE button on remote controller to select required image mode.

Light source (LAMP)

Press the LAMP button on remote controller to change screen brightness.

-  Normal.....Normal brightness.
-  Eco.....Lower the brightness and reduce energy consumption, thus prolonging the light source service life.

INFO.(INFO.)

Press the information button on the remote control to display the information of the projected image and the projector's operating status.

Blank (BLANK)

Press the BLANK button on remote controller; a blank screen displays to replace existing image. Press the BLANK button or any other button to restore the image. Press the BLANK to toggle switch your screen as shown below:

BLANK → Normal → BLANK → Normal →

✓ Note:

For some other buttons' description, please refer to the next page.

Remote controller

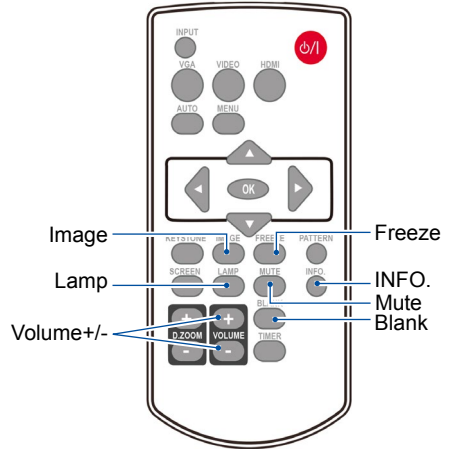

The BLANK screen disappears if no buttons are pressed in 2 seconds.

Basic operation

Timer (TIMER)

Press the TIMER button on remote controller.
A timer animation (00:00) displays on the upper right corner and starts timing in format of (00:00-59:59).

Press the TIMER button to stop timing. Press the TIMER button again to disable the timing function.



Timer display

Digital Zoom + (D.ZOOM+)

Press the D.ZOOM+ button on remote controller to enter the Digital Zoom mode.
When OSD menu disappear, the screen display digital zoom + information.

Press ▲▼◀▶ button to shift the image.

*** When the size of the image is larger than the screen, the shift function will be vaild in DigitalZoom mode.**

Digital Zoom - (D.ZOOM-)

Press the D.ZOOM- button on remote controller to enter the Digital Zoom mode.
When OSD menu disappear, the screen display digital zoom - information.

Press any other key to exit the Digital Zoom + / - mode

Screen size selection (SCREEN)

Press the SCREEN button on remote controller to select required screen size mode.

Press the SCREEN button on the remote control to select the size of the screen to return to the normal screen size.

Remote controller

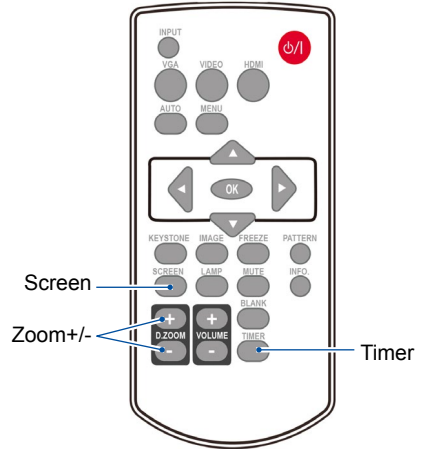

Input selection

Basic operation

Press the INPUT button on the side control panel or on the remote control to select one of the following input: VGA 1, VGA 2, Component, Video, S-Video, HDMI 1, HDMI 2(MHL), DVI, Memory Viewer, Network, USB Display. Alternatively, you may press the VGA, HDMI VIDEO button on remote control to select VGA1, VGA2, HDMI, HDMI 2(MHL), VIDEO, COMPONENT, S-VIDEO.

Remote controller

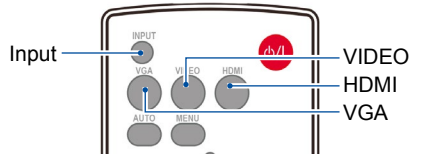

Side Control Panel

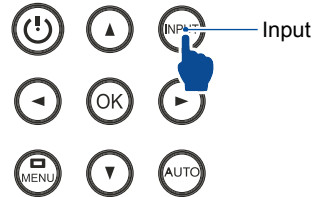

Menu operation

- 1 Press the INPUT button on remote controller to enter the Input menu.
- 2 Press ▲▼ button to select one of the following input: VGA 1, VGA 2, Component, Video, S-Video, HDMI 1, HDMI 2(MHL), DVI, Memory Viewer, Network, USB Display, and then press the OK button to select the input source.

VGA 1

Select input VGA 1 if a PC is connected to the VGA IN 1 terminal.

VGA 2

Select input VGA 2 if a PC is connected to the VGA IN 2 terminal.

HDMI 1

Select input HDMI 1 if a device is connected to the HDMI terminal.

HDMI 2(MHL)

Select input HDMI 2(MHL) if a device is connected to the HD MI 2(MHL) terminal.

Input menu



✓ Note:

- If the " Input search" function in the Auto Setup option is set to "On", once you press the AUTO button, the projector will search for input signals automatically.

Basic operation

Component

Select input Component if a PC is connected to the YPbPr terminal.

Video

Select input Video if a PC is connected to the VGA 2 terminal.

S- Video

Select input S-Video if a device is connected to the S-VIDEO terminal.

Network

Select input Network if a device is connected to the LAN terminal.

Memory Viewer

Select input Memory Viewer if a device is connected to the USB-A terminal.

USB Display

Select input USB Display if a device is connected to the USB-B terminal.

Remote controller

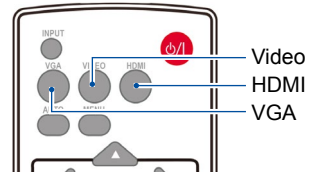

Side Control Panel

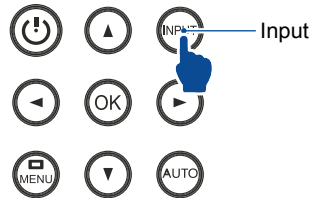

Input menu



✓ Note:

- If the "input search" function in the Auto Setup option is set to "On", once you press the AUTO button, the projector will search for input signals automatically. The AUTO searching function maybe invalid for input of "USB Display", "Memory Viewer" and "Network".
- The following function will be invalid : Freeze, Aspect, Auto setup, and Pattern and Screen, once "USB Display", "Memory Viewer", "Network" has been selected as signal input.
- For further details about Memory Viewer function, please turn to page 69-71.
- For further details about USB Display function, please turn to page 71-73.

Auto PC adj.

Select Auto PC Adj. function can adjust Fine sync, H position, V position, H size to be compatible with the computer automatically.

Menu operation

AUTO PC adj.

Press < MENU > button on the remote controller or on the side control panel to display the OSD menu.

Press ▲▼ button to select the Display menu, then press <OK> or ► button.

- 1) Press ▲▼ button to select [Auto PC adj.] menu.
- 2) Press <OK> button.

AUTO PC adj. menu

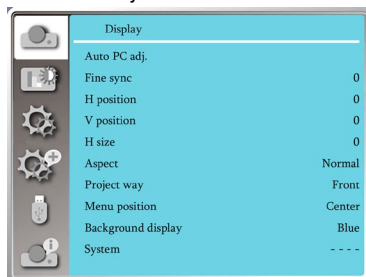

Fine sync

(Only for PC signal input)

Adjust image to the best state when the image jitters, or the image outline dims.

- 1) Press ▲▼ button to select [Fine sync] menu.
- 2) Press <OK> button.
- 3) Press ▲▼ button to adjust Fine sync.

Adjustment range is from 0 to +31. Please adjust to the least interference state.

H Position

(Only for PC signal input)

On the premise that the relative position of both projector and the screen is set up right, you can move the image horizontal position, if the position of the projected image on the screen is deviated.

- 1) Press ▲▼ button to select [H Position] menu.
- 2) Press <OK> button.
- 3) Press ▲▼ button to adjust image H position.

Adjustment range is from -5 to +5.

✓ Note:

- The projector will perform Auto PC Adjustment function automatically when its signal is input for the first time.
- Auto PC Adjustment function may fail to work if computer models are not compatible with the input signal.
- Auto PC Adjustment function may fail to work if you select the following system signal format: 480i, 576i, 480p, 576p, 720p, 1080i, 1080p, or signals from the HDMI terminal.

Display

V Position

(Only for PC signal input)

On the premise that the relative position of both projector and the screen is set up right, you can move the image vertical position, if the position of the projected image on the screen is deviated.

- 1) Press ▲▼ button to select [V Position] menu.
- 2) Press <OK> button.
- 3) Press ▲▼ button to adjust image V position.

Adjustment range is from -5 to +5.

H size

(Only for PC signal input)

You can adjust and reduce the interference caused by patterns of the projected vertical stripes. The following projected patterns may cause a circular pattern (Noise). Adjust the amount of interference to the minimum. Users can point the clock to adjust images.

- 1) Press ▲▼ button to select [H size] menu.
- 2) Press <OK> button.
- 3) Press ▲▼ button to adjust H size level .

Adjustment range is from -15 to +15.

Aspect

Adjust the image to fit the screen size, while keeping aspect of input signal's unchanged.

Press < MENU > button on the remote controller or on the side control panel to display the OSD menu. Press ▲▼ button to select the Display menu, then Press <OK> or ► button.

- 1) Press ▲▼ button to select [Aspect] menu.
- 2) press <OK> button.
- 3) Press ▲▼ button to select the required item.

Normal....Use the maximum size to project while keeping the aspect of input signal's unchanged.

Wide.....Project images at the aspect of 16: 9.

Full.....Project images to the maximum.

- Only for VGA1 and HDMI as signal input.

Aspect menu

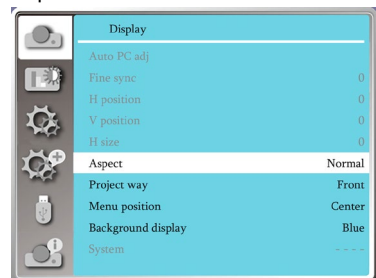

Project way

Select this function to set the project way .
Please change the projection way,if the OSD displays inversely or reversedly.

Press < MENU > button on the remote controller or on the side control panel to display the OSD menu. Press ▲▼button to select the Display menu ,then press <OK> or ►button.

- 1) Press ▲▼ button to select [Project way] menu.
- 2) press <OK> button.
- 3) Press ▲▼ button to switch .

Front : when the projector is installed on the table and projected in front of the screen.

Rear : when the projector is installed on the table and projected in rear of the screen (using translucent screen)

Ceiling / Front : when use the bracket to lift the projector (optional) in front of the screen.

Ceiling / Rear : when use the bracket to lift the projector (optional) in rear of the screen(using translucent screen).

Auto ceiling / Front :when the projector is projected in front of the screen.

Auto ceiling / Rear : when the projector is projected in rear of the screen.

Project way menu

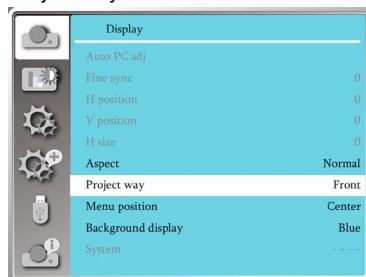

Menu position

Select this function to set the Menu position .
Press < MENU > button on the remote controller or on the side control panel to display the OSD menu.Press ▲▼button to select the Display menu ,then press <OK> or ►button.

- 1) Press ▲▼ button to select [Menu position] menu.
- 2) Press <OK> button.
- 3) Press ▲▼ button to change menu position.

Upper leftThe Menu display on the Upper left corner of the screen.

Upper right....The Menu display on the Upper right corner of the screen.

Center.....The OSD display in the Center of the screen.

Lower leftThe Menu display on the lower left corner of the screen.

Lower right ...The Menu display on the lower right corner of the screen.

Menu position menu

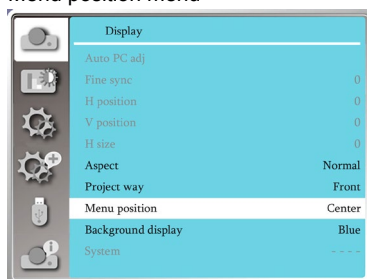

Display

Background display

Select this function can adjust background color. Press < MENU > button on the remote controller or on the side control panel to display the OSD menu. Press ▲▼ button to select the Display menu ,then press <OK> or ► button.

1) Press ▲▼ button to select [Background display] menu.

2) Press <OK> button.

3) Press ▲▼ button to select required item .

Blue..... The entire projection area display blue.

Black.....The entire projection area display black.

Background display menu

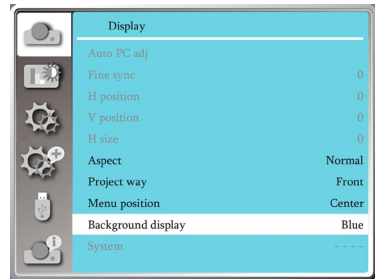

✓ **Note:**

This function will be invalid once you select input signal as USB Display,Memory viewer and Network.

System

System selection

The scanning system and auto computer adjustment function may detect scores of signal format. If a PC is selected as the input signal source, your projector will detect and adapt to its signal format automatically. Correct image can be displayed without any setup operation.

Your projector will display one of the following:

Auto If your projector failed to identify signals not shown in the signals format table, the "Auto" message will display in the System Signal Format menu. The Auto PC Adjusting function will make necessary adjustment to your projector to project valid images. If images are displayed incorrectly, adjust it manually.

----- No PC signals detected. Check the connection between PC and your projector.

Computer system menu

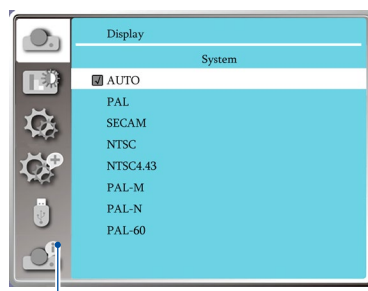

The selected system displays in the PC system menu.

✓ Note:
Your projector may save data generated by the Auto PC Adjust. function.

Select the computer system manually

- 1 Press the MENU button on remote controller or on the side control panel and the OSD displays. Press ◀▶ button to point to the Input icon, press ▲▼ button or OK button and the Input menu displays.
- 2 Press ▲▼ button to select System Signal Format, then press OK button.
- 3 Press ▲▼ button to select required system signal format, then press OK button to confirm your selection.

✓ Note:
The computer system menu will be disabled once HDMI 1, HDMI 2(MHL), Memory Viewer, Network, USB Display has been selected.

Display

Video / S-Video

Select this function to set resolution of input signal is compatible with the PC.

Set Video / S-Video input signal color system or Component input signal scanning mode.

- 1) Press ▲▼ button to select [System] menu.
- 2) Press <OK> button.
- 3) Press ▲▼ button to select wanted system.

RGB input signal

1024x768 60HZ, etc:display the compatible name input signal name.

Auto: When projector has no compatible input signal with one from connected PC ,the PC can adjust automatically to run and Auto appear on the system. If the image is not projected out correctly, please adjust it to match your computer manually.

---: No signal input come from PC. Please check the connections.

Video / S-video input signal

Auto: When projector select the input signal color system automatically. set [PAL-M] or [PAL-N] manually .

[PAL]/[SECAM]/[NTSC]/[NTSC4.43]/[PAL-M]/[PAL-N]/[PAL60]:When projector can not display images correctly in [Auto], please set input signal color system manually.

Component input signal

Auto: When projector select input signal scanning mode automatically.

[1080p]/[1080i]/[720p]/[576p]/[480p]/ [576i]/[480i]:When projector can not display images correctly in [Auto], please set scanning mode on the left manually.

Computer system menu

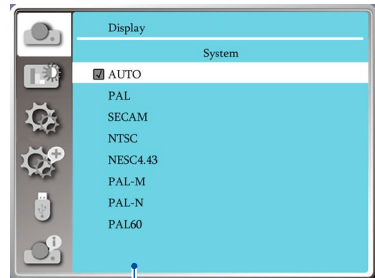

Video / S-Video displays in the PC system menu.

Select color Adjustment to set the image mode and adjust the quality of the projected image

Image mode

Direct operation

Press the Image Select button on remote controller to select required image mode.

Menu operation

Press < MENU > button on the remote controller or on the side control panel to display the OSD menu. Press ▲▼ button to select the Color adjust menu ,then press <OK> or ►button.

- 1) Press ▲▼ button to select [Image mode] menu.
- 2) Press <OK> button.
- 3) Press ▲▼ button to select required item.

Dynamic

An image mode suitable for viewing in bright room.

DICOM

A highly clear X-ray image is reproduced. Digital radiographs with excellent detail and clarity for medical training, presentations and conferences.

Normal

The default mode of your projector ,can come to national color.

Cinema

Enriched grayscale for viewing movies.

Blackboard (Green)

An image mode designed for displaying on a blackboard (Green). It boosts quality of image projected on blackboard (Green). This is designed for a board in green rather than black as indicated by its name.

Colorboard

A image mode suitable for image projecting on surface of wall in red, blue, yellow or green. Press <OK> button. to enter colorboard menu,then press ▲▼ button to select Red ,Blue ,Yellow or Green,Press <OK> button.

User Image

Default image mode set by users in the Image Adjust menu.

Remote controller

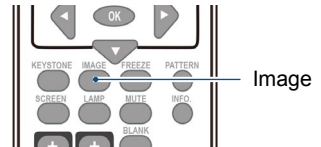
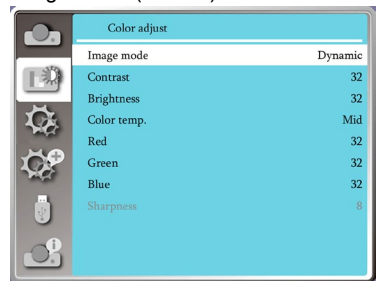
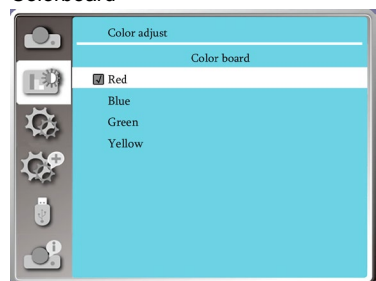

Image mode (For PC)



Colorboard



Color adjust

Color adjust(For PC.)

Press < MENU > button on the remote controller or on the side control panel to display the OSD menu. Press ▲▼button to select the Color adjust menu , then press <OK> or ►button.

- 1) Press ▲▼ button to select required item .
- 2) Press <OK> button.
- 3) Press ▲▼ button to adjust setpoint .

Contrast

Press▼button to decrease contrast, range from 0 - +63.

press ▲ button to increase contrast,range from 0 - +63.

Brightness

Press▼ button to decrease brightness, range from 0 - +63.

press ▲button to increase brightness, range from 0 - +63.

Color temp.

Press ▲▼button to select required color temperature (Low, Mid. and High)

High temp:Become blue gradually.

Mid temp:Suitable natural color.

Low temp:Become red gradually.

Red

Press ▼button to decrease red tint and ▲ button to increase it.

Green

Press ▼button to decrease green tint and ▲button to increase it.

Blue

Press ▼button to decrease blue tint and ▲ button to increase.

Sharpness

Press ▼ button to soften image and ▲ button to sharpen, range from 0 - +15.

Color adjust(For PC)

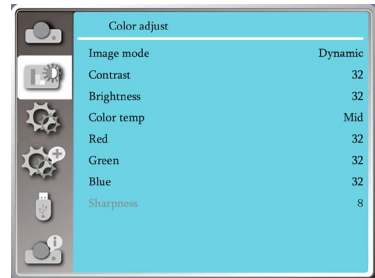

✓ **Note:**

- Tint and color option are available if you chose Video, S - Video or Component as signal, while other signals result in two of them invalid.

Color adjust(For Video, S-video or Component)

Press < MENU > button on the remote controller or on the side control panel to display the OSD menu. Press ▲▼ button to select the Color adjust menu , then press <OK> or ► button.

- 1) Press ▲▼ button to select required item .
- 2) Press <OK> button.
- 3) Press ▲▼ button to adjust setpoint .

Contrast

Press ▼ button to decrease contrast, range from 0 - +63.
press ▲ button to increase contrast, range from 0 - +63.

Brightness

Press ▼ button to decrease brightness, range from 0 - +63.
press ▲ button to increase brightness, range from 0 - +63.

Color

Press ▼ button to decrease saturation, press ▲ button to increase saturation.

Tint.

Press ▲▼ button to select required tint.

Red

Press ▼ button to decrease red tint and ▲ button to increase it.

Green

Press ▼ button to decrease green tint and ▲ button to increase it.

Blue

Press ▼ button to decrease blue tint and ▲ button to increase.

Sharpness

Press ▼ button to soften image and ▲ button to sharpen , range from 0 - +15.

Color adjust(For Video, S-video , Component)

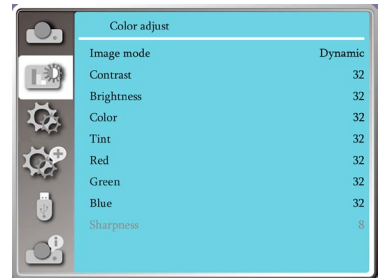

✓ **Note:**

- Tint and color option are available if you chose Video, S - Video or Component as signal, while other signals result in two of them invalid.

Setting

The projector has Setting function, you can select other functions as described below.

Menu operation

Press < MENU > button on the remote controller or on the side control panel to display the OSD menu. Press ▲▼ button to select the Setting menu ,then press <OK> or ► button.

- 1) Press ▲▼ button to select required item.
- 2) Press <OK> button.
- 3) Press ▲▼ button to set options.

On start

Set the power mode ON , when the power cord is connected to a power outlet.

- 1) Press ▲▼ button to select [On start] menu.
- 2) Press <OK> button.
- 3) Press ▲▼ button to select required item.

Off..... Get into Standby mode.

On.....Start up immediately.

Standby mode

Set power consumption in standby mode,no matter whenever your projector is operated through network

- 1) Press ▲▼ button to select [Standby mode] menu.
- 2) Press <OK> button.
- 3) Press ▲▼ button to adjust levels.

ECO mode.....Some function will be disabled once your projector is in ECO. STANDBY mode to reduce power consumption. Network and RS-232C serial communication will be unavailable except the POWER ON command during that mode.

Normal.....Even in standby mode,there are no restraint on network function and serial communication function.

- On Standby mode, network can work well only by Wake On LAN software.

Setting menu

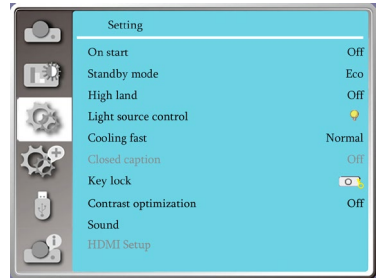

On start

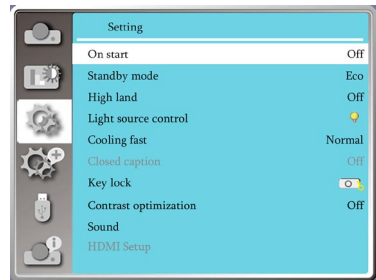

Standby mode

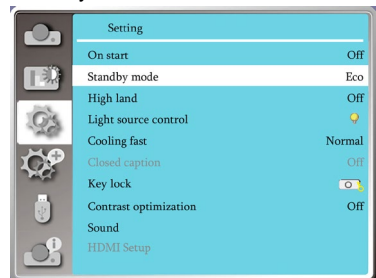

✓ Note:

- For details on Wake On LAN, please refer to page 67-68.

High land

This projector provides Fan control function in the settings menu. You can change the setting about speed of cooling fan according to the altitude your projector is operating at.

- 1) Press ▲▼ button to select [High land] menu.
- 2) Press <OK> button.
- 3) Press ▲▼ button to select required menu.

Off: Normal speed. Set the option OFF when operating the operator, if the altitude is not too high .

On: Faster than when in Off mode .Set the option ON when operating the operator in high land .

✓ Note:

- Set high land option ON when you operate the operator at an altitude of 1400-2700 meters.

Light source control

Change lamp brightness according to the environment and aim your projector is operating.

- 1) Press ▲▼ button to select [Light source control] menu.
- 2) Press <OK> button.
- 3) Press ▲▼ button to switch required menu.

💡 Normal.....Normal brightness.

💡 Economical.....Lower the brightness and reduce power consumption to prolong the light source's life .

Cooling fast

After your projector is powered off, select cooling fan speed to shorten the cooling time .

- 1) Press ▲▼ button to select [Cooling fast] menu.
- 2) Press <OK> button.
- 3) Press ▲▼ button to switch required menu.

Normal.....Running in normal way.

30 seconds.....Running faster than in normal mode with shorter time but a louder sound.

0 seconds.....Select this function allow you to unplug the AC power directly after the shutdown, without waiting for it cooling off.

High land

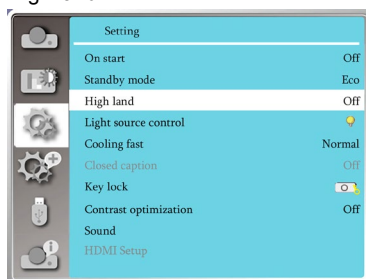

Light source control

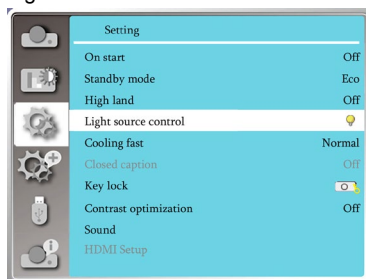

Cooling fast

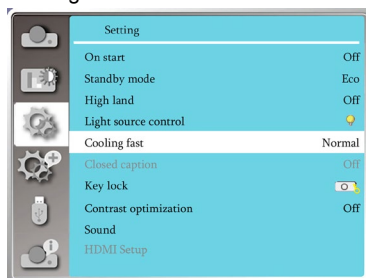

Setting

✓ **Note:**

- When set the option 0 seconds, user cannot restart the projector immediately after turning off.
- Sometimes, the light source may take longer time to start again than usual time during the high temperature.

Closed caption

Closed Caption is used for displaying the program sound or other information on the screen. Select this function to switch channel with input signal of closed caption .

- 1) Press ▲▼ button to select [Closed caption] menu.
- 2) Press <OK> button.
- 3) Press ▲▼ button to switch required menu.

OFF:No closed caption.

CC1.....Display CC1 data.

CC2.....Display CC2 data.

CC3.....Display CC3 data.

CC4.....Display CC4 data.

✓ **Note:**

- The icon display gray if the Closed caption function is invalid.
- The Closed caption function is invalid when the OSD menu and Timer display on the screen.

Closed caption

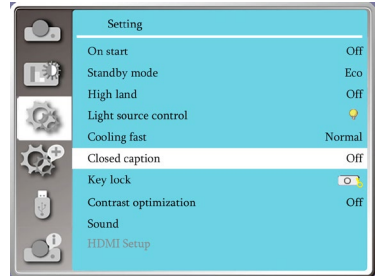

Key lock

Select this function to lock and unlock the control panel or remote controller keypad.

- 1) Press ▲▼ button to select [Key lock] menu.
- 2) Press <OK> button.
- 3) Press ▲▼ button to switch required menu.

☺ Off.....The control panel or remote controller keypad are effective.

☹ Projector.....Control panel keypad is invalid.

☹ Remote controller.....Remote controller keypad is invalid.

✓ **Note:**

- If you lock the top of the control panel, but without a remote controller or something wrong with the remote controller, please contact your dealer or service center.

Key lock

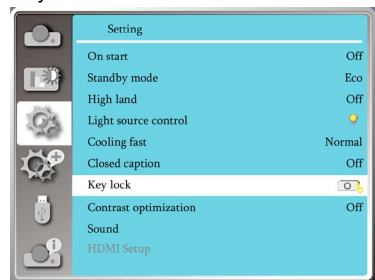

Contrast optimization

Select this function to correct and compensate signal automatically on the basis of the image, to get the best contrast image.

- 1) Press ▲▼ button to select [Contrast optimization] menu.
- 2) Press <OK> button.
- 3) Press ▲▼ button to adjust levels.

Off.....NO optimization.

On.....Optimize contrast.

Contrast optimization

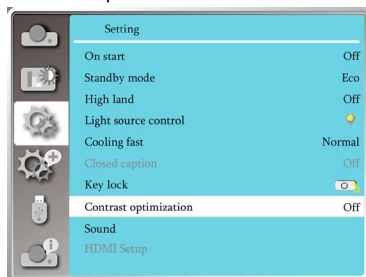

Sound

Select this function to adjust the sound.

- 1) Press ▲▼ button to select [Sound] menu.
- 2) Press <OK> button.
- 3) Press ▲▼ button to switch required menu.

Volume.....Press▼button to increase volume,range from 0~+25.
Press▲button to decrease volume,range from 0~+25.

Mute..... Press ▲▼ button to switch on or off Mute function.

On:No audio output.

Off:Audio output.

Sound

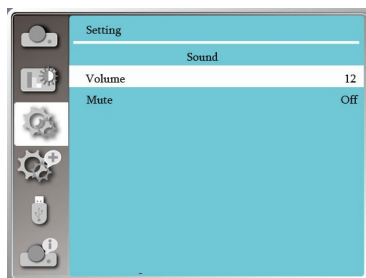
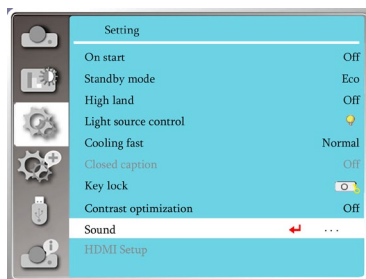

Setting

HDMI setup

When the external device is connected to the HDMI terminal of the projector, and the images can not be projected normally, please switch on the Image or Sound setting.

Press < MENU > button on the remote controller or on the top control panel to display the OSD menu. Press ▲▼ button to select the Setting menu ,then press <OK> or ► button to enter the sub-menu.

- 1) Press ▲▼ button to select [HDMI setup] menu.
- 2) Press <OK> button.
 - Display [HDMI Setup] instantly.
- 3) Press ▲▼ button to select [Image] or [Sound] .
- 4) Press <OK> button.

HDMI Setup

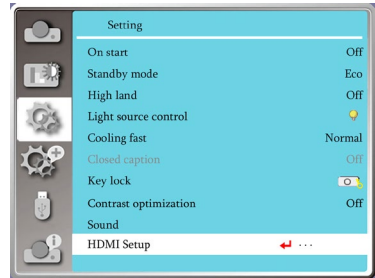

✓ **Note:**

- HDMI option can be chosen onlu in HDMI 1 and HDMI 2 (MHL) channel.

Image

[64-940]	When external device (such as:a blu ray disc player) is connected to the HDMI setup terminal .
[0-1023]	When the output of an external device (such as a computer), via a conversion cable or a similar cable ,is connected to the HDMI setup terminal. Select this option when the output of the PC or any other device is connected to the HDMI setup terminal also.

✓ **Note:**

- The best settings about projectors may differ slightly from your external output device .
- For external output, please refer to the instructions for use of the external device.

Sound

[HDMI]	When connect to the HDMI cable to tansmite images and audio while the users donot need connect to audio signal separately.
[Computer]	When the output of an external device (such as a computer), via a conversion cable or a similar cable ,is connected to the HDMI terminal . The audio signal would be output according the connection of AUDIO IN terminal.

The projector has Expand function, you can select other functions as described below.

Menu operation

Press < MENU > button on the remote controller or on the side control panel to display the OSD menu. Press ▲▼button to select the Expand menu ,then press <OK> or ►button.

- 1) Press ▲▼ button to select required item.
- 2) Press <OK> button.
- 3) Press ▲▼ button to set options.
- 4) Press <OK> button.

Expand menu

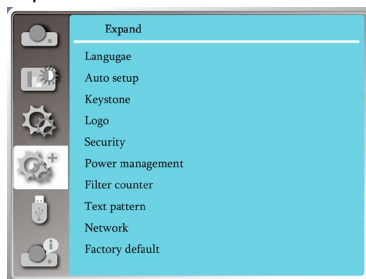

Language

Users can selected the language displayed on the screen .

- 1) Press ▲▼ button to select [Language] menu.
- 2) Press <OK> button.
- 3) Press ▲▼ button to select required language.
- 4) Press <OK> button.

The name of menus, setting, the OSD, button etc., can displayed by the selected language.

Your projector comes with multiple language support. You may select required one from them,such as:English, German, French, Italian, Spanish, Polish, Swedish, Dutch, Portuguese, Japanese, Simplified Chinese, traditional Chinese, Korean, Russian,Arabic, Turkey, Finland, Norway, Denmark, Indonesia, Hungary, Czech Republic, Kazakhstan, Vietnamese, Thai, Farsi.

Language

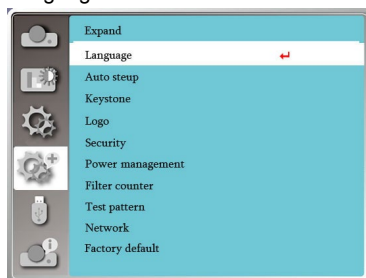

Expand

Auto setup

Press the AUTO button on your remote controller to execute the following functions : Input search, Auto PC adj. , and Auto keystone.

- 1) Press ▲▼ button to select [Auto setup] menu.
- 2) Press <OK> button.
- 3) Press ▲▼ button to select required items.

Input search : Select this function to detect the signal, then project images and input signals automatically .

Auto PC adj. : Select this function to adjust [Fine sync], [H Position], [V Position] and [H Size] automatically, when projector input analog signals.

Auto setup

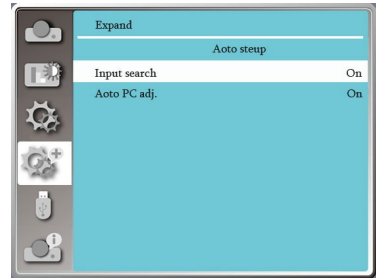

Keystone

Select this function to store or reset the Keystone or some related setting after unplugging the AC power.

Press < MENU > button on the remote controller or on the top control panel to display the OSD menu. Press ▲▼ button to select the Expand menu ,then press <OK> or ► button to enter

- 1) Press ▲▼ button to select [Keystone] menu.
- 2) Press <OK> button.
- 3) Press ▲▼ button to select required item.
- 4) Press <OK> button.

Keystone

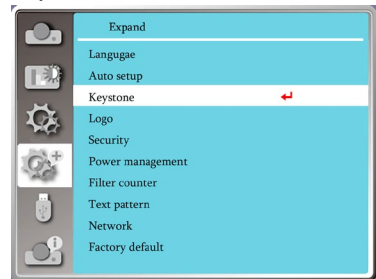

Keystone

Select this function to store and reset Keystone after closing the projector or unplugging the AC power .

Store.....Store Keystone after closing the projector or unplugging the AC power cord .

Reset value.....Keystone function will be cancelled after closing the projector or unplugging the AC power.

Keystone sub-menu

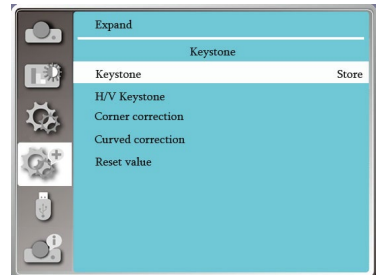

H/V Keystone

Select this function to correct the projected images horizontally or vertically

Press ▲ button to reduce upper width

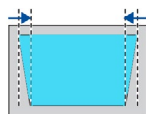

Press ▼ button to reduce bottom width

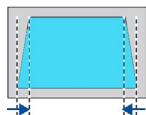

Press ◀ button to reduce left width

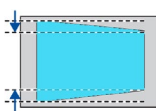

Press ▶ button to reduce right width

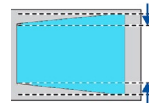
**Conner correction**

Select this function to correct the projected images of four corners distorted.

Press ▲▼◀▶ button to keystone at four corners of the screen.

The four corners are looped in sequence shown below:

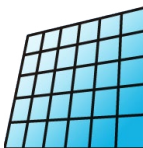
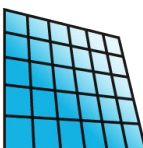
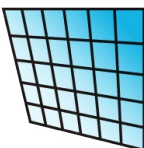
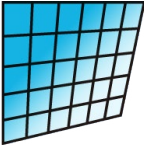
Conner correction			
Upper left	Upper right	Bottom left	Bottom right
			

Curved correction

Select this function to correct the projected images with linearity uneven or vertical and horizontal bending deformation.

Press ▲▼◀▶ button to adjust options.

- WUXGA series cannot support curved correction fuction

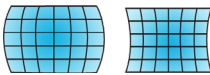
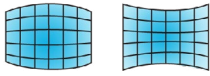
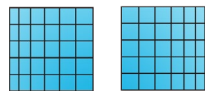
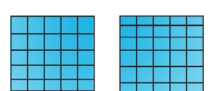
Item	Operation	Adjustment	
Curved correction X/Y gain	Press ▶	Adjust right width	
	Press ◀	Adjust left width	
	Press ▲	Adjust top width	
	Press ▼	Adjust bottom width	
Curved correction X compensation	Press ▶	Adjust distortion on the right	
	Press ◀	Adjust distortion on the left	
Curved correction Y compensation	Press ▲	Adjust distortion on the top	
	Press ▼	Adjust distortion on the bottom	

Expand

✓ **Note:**

- After adjusting values about H/V Keystone , if users adjust Conner correction, values about H/V Keystone will be reset . And after adjusting values about Conner correction, if users adjust about H/V Keystone, values about Conner correction will be reset also.
- Curved correction X compensation and Curved correction Y compensation can not be adjusted individually. Adjust Curved correction X compensation and Curved correction Y compensation after adjusting the X/Y Curved correction.
- Press KEYSTONE button on the remote control, then the Keystone OSD menu appears (includes: H / V keystone , Conner correction, Curved correction and Reset value), and press ▲▼ button to switch the four options .
- Maximum Keystone range up to $\pm 5^\circ$ vertically and $\pm 5^\circ$ horizontally. However, the image quality will deteriorate, and become more difficult to focus. Install the projector with the minimal correction value.
- The screen size will be changed with various H/V Keystone adjustments .
- Keystone may influence image aspect .

Reset value

Select this function to make adjustment value back to the factory default .

- 1) Press ▲▼◀▶ button to select [Reset value] option.
- 2) Press <OK> button.
 - Release Keystone mode.

Logo

Logo (including Logo and Logo PIN Code lock setup)
You may use this function to select Logo screen, Logo PIN Code lock, change power on password, and set up default logo screen.

- 1) Press ▲▼ button to select [Logo] menu.
- 2) Press <OK> button.
- 3) Press ▲▼ button to select required items.

Logo Select

Select this to set up the logo screen when power on your projector:

Normal....Display factory default logo screen.

User.....Display capture logo screen.

Off.....No image.

Capture

Enable us to capture images being projected and use it for a startup display or interval of presentations. Upon capturing the projected image, press OK button, then a confirmation box appears, Select Yes to capture it .

After capturing the projected images, go to "select a logo", and set it to "User". Then, the captured image is displayed when the projector is turned on next time.

Logo PIN Code lock

LOGO PIN Code lock

This function helps preventing unauthorized personnel from changing the Logo screen.

Off.....The Logo screen may be changed with the Logo menu..

On.....You may not alter the logo screen without the Logo PIN Code.

To change the logo screen password protection, press OK key, and the Logo PIN Code change popup dialog box prompts. Follow steps below to enter a logo screen password.

- Press arrow ◀▶ button to select a number, then press OK button to enter it and move the cursor. The number you typed is displayed as " * ". To edit number you have entered, press MENU button to move the cursor to the number you want to change, press ▲▼ button to select the correct one.
- Repeat this step to type in a 3-digit number. Move the cursor to SET after you have typed the 3-digit number. Press OK button.
- If the password is invalid, the password displayed as " *** " will be in red. Please try again with a valid one.
- After entering valid logo screen PIN code, you may press ◀▶ button to toggle switch Off and On.

Logo PIN Code Change

You may change the Logo PIN Code to any 3-digit number you like. Press OK key to select Logo PIN Code change. The Logo PIN Code change dialog box prompts, press arrow ◀▶ button to give a valid new code. The New Logo PIN Code dialog box prompts. Set up a new Logo PIN Code, check contents contained in the dialog box, select Yes and the new password is set now. Please remember your new password and keep it safe.

You cannot change the Logo PIN Code again if you forgot the password you have set. If the password is lost or forgotten, the projector will remain in the Logo PIN code lock and will not be available.

Logo menu

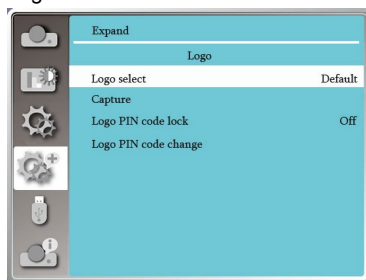

✓ Note:

- After changing the Logo PIN Code to a new number, please remember it and keep it safe. The Logo PIN Code cannot be changed again if the new password is lost or forgotten.

Expand

Security

Set a password to lock the control panel or remote controller keypad to prevent unauthorized personnel from operating your projector. Once the projector is on, the [Enter Logo Password] screen will be displayed.

- 1) Press ▲▼ button to select [Security] menu.
- 2) Press <OK> button.
- 3) Press ▲▼ button to switch required item.

Logo PIN Code lock

LOGO PIN Code lock

This function helps preventing unauthorized personnel from changing the Logo screen.

Off.....The Logo screen may be changed with the Logo menu.

On.....The [Logo Password] screen will appear when the projector is on.If you want to change the PIN Code Lock or password (for three digits), you must enter the password. The factory default password is "111."

Security menu

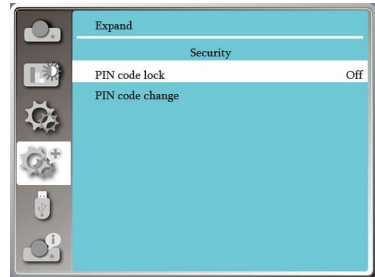

Reset password

- To change the logo screen password protection, press OK button, and the Logo PIN Code change popup dialog box prompts. Press arrow ◀▶ button to select a number, then press OK button to enter it and move the cursor.
- The number you typed is displayed as “ * ”. To edit number you have entered, press MENU button to move the cursor to the number you want to change, press ◀▶button to select the correct one.
- Repeat this step to type in a 3-digit number.
- Enter a three-digit number, move the cursor to "set" . Press the OK button, you can start to operate the projector.
- If the password is invalid, the password displayed as “ *** ” will be in red. Please try again with a valid one.

Logo PIN Code Change

You may change the Logo PIN Code to any 3-digit number you like.

Press OK key to select Logo PIN Code change.

The Logo PIN Code change dialog box prompts, press arrow ◀▶button to give a valid new code.

The New Logo PIN Code dialog box prompts. Set up a new Logo PIN Code, check contents contained in the dialog box, select Set and the new password is set now.

Please remember your new password and keep it safe. You cannot change the Logo PIN Code again if you forgot the password you have set.

✓ **Note:**

- After changing the Logo PIN Code to a new number, please remember it and keep it safe. The Logo PIN Code cannot be changed again if the new password is lost or forgotten.

Power management

To reduce power consumption and maintain life cycle of light source, the power management function will turn off the projection light source if your projector has no signals for a period of time.

- 1) Press ▲▼ button to select [Power management] menu.
- 2) Press <OK > button.
- 3) Press ▲▼ button to switch required item.

Ready.....The POWER light indicator flashes green when the lamp is fully cooled down. The light source turns on again if an input signal is connected or any key (except the  power button) on the side panel and remote controller is pressed during this period of time.

Power Off.....The projector shut down after the light source is fully cooled down.

Off.....Disable the power management function.

Timer.....Once the input signal is interrupted and no keys has been pressed for 30 seconds afterwards, the "No signal" message displays in the timer. The timer counts down until the light source turns off. Press arrow key to set up the timer in range of 1~30 minutes.

Ready Countdown...Set the interval from ready mode change to standby mode (0 to 30 minutes) automatically. When it is set it to zero, the projector will never change automatically. Press the Power key to change your projector into standby mode and any other key to power on.

Power management menu

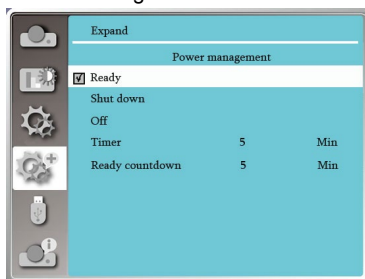

Power management

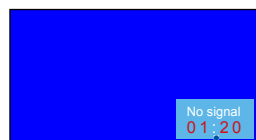

Remaining time before poweroff the light source

✓ **Note:**

- Factory default for standby time: 5 minutes. Count down for ready mode: 5 minutes.

Expand

Filter counter

Set this function to reset the filter usage time and set up warning display.

- 1) Press ▲▼ button to select [Filter counter] menu.
- 2) Press <OK> button.
- 3) Press ▲▼ button to switch required item.

When the projector reaches the user-set cleaning time, filter warning icon will appear on the screen to notify the user needs to clean the projector filter. please make sure to select the initial state and set the timer after cleaning it. once resetting filter counter, filter warning icon will be closed.

Filter.....Displays the filter usage time.

Timer.....Set the time to display a warning icon.

Filter counter resetreset filter counter.

Filter counter menu

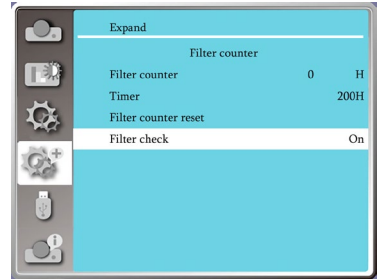

Test pattern

Select this function to display the projector's built-in test pattern.

Location, size, and other factors cannot be reflected in the test pattern. Please make sure to display the input signal before performing various adjustments.

- 1) Press ▲▼ button to select [Test pattern] menu.
- 2) Press <OK > button.
- 3) Press ▲▼ button to switch required item.
- 4) Press <OK> button.

Gray scale 1 / Gray scale 2 / Gray scale 3 / Gray scale 4 / Color bar / Red / Green / Blue / Cross hatch / White / Black / Raster gray: Use The OSD menu to display the test pattern. Choose the test mode can help you making a series of adjustments easily.

Test pattern menu

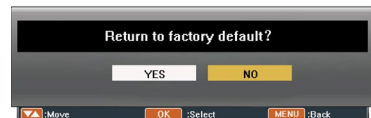
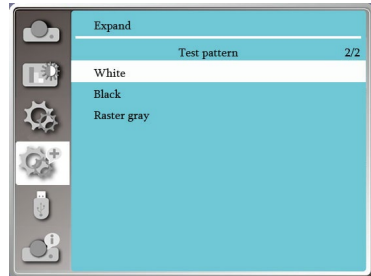
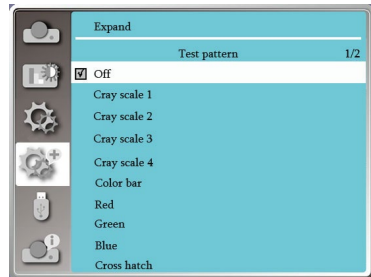

Factory default

This function resets all your settings to factory default .

- 1) Press ▲▼ button to select [Factory default] menu.
- 2) Press <OK or ►> button.
- 3) Press ◀▶ button to select YES ,then press <OK> button.

Network

Function: This function is designed to allow the computer control the projector remotely via intranet.

Preparation

- 1 Required equipment: Projector, computer, network cable
- 2 Connection:
Connect your projector to a router or switch in the LAN with normal or jumper network cable. In case a normal network cable failed to connect successfully, use a jumper cable instead.
- 3 Turn on the computer. The LAN port on computer and projector are flashing after power on the projector.

Operation steps

- 1 Power on your projector.
- 2 Acquire the IP address, with DHCP set to on and auto IP allocation set to On. (You may set DHCP to Off and set up IP address manually if you are somehow familiar with networking.)
- 3 Enter the network setup menu
 - (1) Press MENU button on remote controller or top of the control panel, press ▲▼ button to select network icon.
 - (2) Press ▲▼ button select network settings and press OK button to enter.
MAC address.....Display the MAC address of wired network.
IP address.....Display the IP address of wired network.
 - (3) Press ▲▼ button to set DHCP On to obtain an IP address, subnet , gateway and DNS automatically , and press OK button to confirm.

Press ▲▼ button to set DHCP Off, then press OK button to enter an IP address, then press ▼ button to select subnet , gateway and DNS automatically. And press OK button to confirm.

Network menu

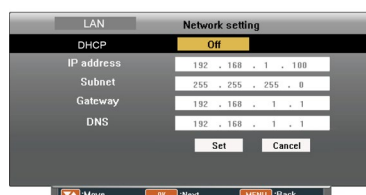
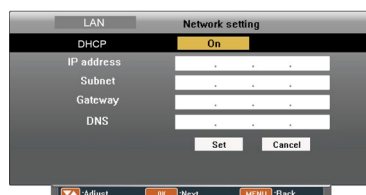
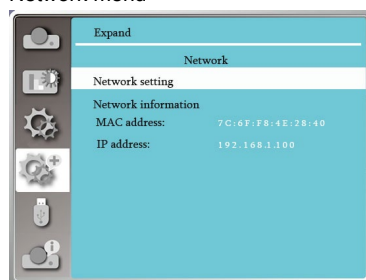

Memory Viewer

Select Memory Viewer function can project images stored in USB memory,when you insert the USB memory into the projector.

Press < MENU > button on the remote controller to display the OSD menu.Press ▲▼button to select the Memory Viewer menu ,then press <OK> or ►button.

- 1) Press ▲▼ button to select required item.
- 2) Press <OK> button.
- 3) Press ▲▼ button to set options.
- 4) Press <OK> button.

Set slide

Select this function to play slides.

- 1) Press ◀▶ button to select a file.
- 2) Press ▲▼ button to select [Set slide] menu.
- 3) Press <OK or ► > button.
 - Full screen display
 - Press <OK> to return the thumbnail.

Slide transition effect

Select this function to set the slide's playback ,when switching slides.

- 1) Press ▲▼ button to select [Slide Transition effect] menu.
- 2) Press <OK or ► > button.
- 3) Press ▲▼ button to switch required item.
 - Slide down.....Switch slides from the upper to the lower .
 - Slide right.....Switch slides from left to the right.

Sort order

Select this function to set the slide's order.

- 1) Press ▲▼ button to select [Sort order] menu.
- 2) Press < OK > button.
- 3) Press ▲▼ button to switch required item.
 - Expand order.....Sort by expand names of file or folder.

Size order.....Sort by size of file or folder.

Time order.....Sort by the time of file or folder.

Name order..... Sort by names of file or folder.

Memory Viewer menu

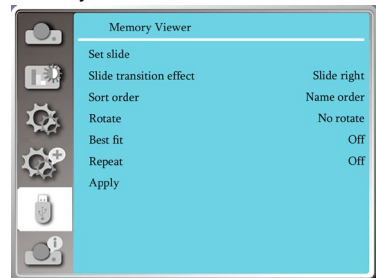

Note:

- When selecting [Memory Viewer] as input signal, the "Memory Viewer" menu is available.
- In addition to "Set slide" menu , even change the settings, If you do not implement the [Application], the setting value of the change is invalid.

Rotate

Set the rotation direction of images.

- 1) Press ▲▼ button to select [Rotate] menu.
- 2) Press < OK > button.
- 3) Press ▲▼ button to switch required item.

No rotateRotation is invalid.

270 degree rotate.....Rotate counterclockwise by
270 degrees.

180 degree rotate.....Rotate clockwise by 180
degrees.

90 degree rotate Rotate clockwise by 90
degrees.

Best fit

Set the image to be compatible with projection screen.

- 1) Press ▲▼ button to select [Best fit] menu.
- 2) Press < OK > button.
- 3) Press ▲▼ button to switch required item.
 - On.....Display images by the aspect ratio of the screen.
 - Off.....Display image by the normal pixels.

Repeat

Select this function to play slides repeatedly.

- 1) Press ▲▼ button to select [Repeat] menu.
- 2) Press <OK or ►> button.
- 3) Press ▲▼ button to switch required item.
 - On.....Replay the first document,after playing
the last one.
 - Off.....Return to the thumbnail display
screen,after playing the last one.

Apply

Only be used in playing slides.

- 1) Press ▲▼ button to select [Apply] menu.
- 2) Press <OK or ►> button.

Info.

Select Info. function to detect the projected image signal and the projector operating status.

Menu operation

Press <Info.> button on the remote controller or <MENU> button on the side control panel to display the OSD menu. Press ▲▼ button to select the Info. menu, then press <OK> or ► button.

Info. display as follows:

Input : Display selected input source.

H- sync. Freq. ...Display H- sync. Freq. of input signal in unit of KHz. Show "---KHz" when no signals are in existence.

V- sync. Freq....Display V- sync. Freq of input signal in unit of KHz. Show "---KHz" when no signals are in existence.

Light source status.....Display the light source status.

Light source counter.....Display the light source's usage time.

Power management.... Display selected Power management mode.

Image mode.....Display selected Image Mode.

Info. menu

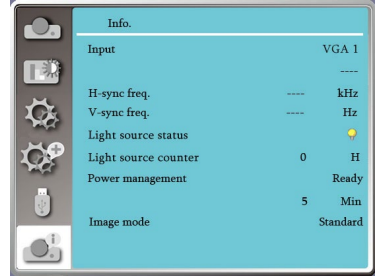

Network control operation

Function: This function is designed to remote control computer in the same LAN.

Preparation

- 1 Required equipment: Projector, computer, network cable
- 2 Connection:
Connect your projector to a router or switch in the LAN with normal or jumper network cable. In case a normal network cable failed to connect successfully, use a jumper cable instead.
- 3 Turn on the computer. The LAN port on computer and projector are flashing after power on the projector.

Operation steps

- 1 Power on your projector.
- 2 Acquire the IP address, with DHCP set to on and auto IP allocation set to On. (You may set DHCP to Off and set up IP address manually if you are somehow familiar with networking.)
- 3 Enter the network setup menu
 - (1) Press MENU button on remote controller or top of the control panel, press ▲▼ button to select network icon.
 - (2) Press ENTER button or ► button and the network menu displays.
 - (3) Press ▲▼ button select network settings and press ENTER to confirm.
 - (4) Press ▲▼ button to set DHCP On and press OK button to confirm.
 - (5) Press ▲▼ button to select Set, press OK button to wait until the “Please wait..” message disappears.

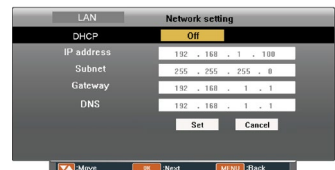
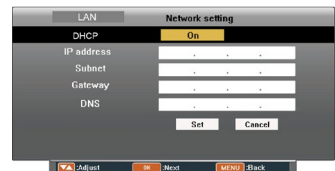
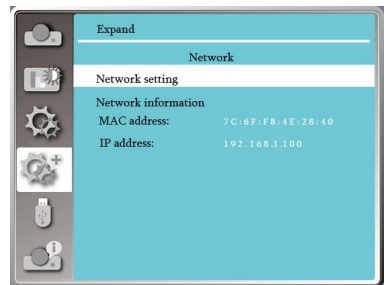

✓ Note:

- If you are using the wireless network connection, please check the SSID / ESSID and wireless IP address in the Network Setting status, and write down the information.

Network control

WI-FI display (For PC.)

Wi-Fi display enable to connect PC with the projector wirelessly to realize high-speed transmission between devices, allowing users to enjoy high-definition video display without the need for cables circumstances.

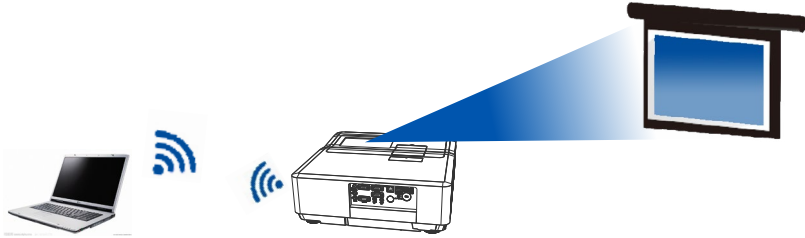

Wireless network setup

1. Inset the supplied WIFI dongle into the USB-A port.
 - For this fuction,users need to purchase the WIFI dongle seperately with your suppliers.

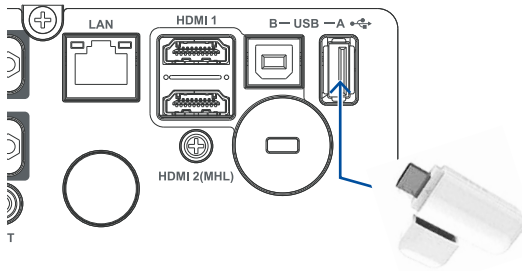

2. Please find "NetworkDisplay" in the Open Network and Sharing Center and click "Connect" to connect the WIFI.



WI-FI display (For Mobile devices)

Wi-Fi display enable to connect any mobile devices with the projector wirelessly to realize high-speed transmission between devices, allowing users to enjoy high-definition video display without the need for cables circumstances.

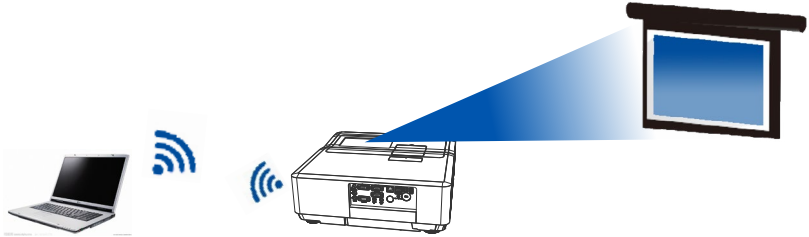

■ Wireless network setup

1. Inset the supplied WIFI dongle into the USB-A port.

- For this fuction, users need to purchase the WIFI dongle seperately with your suppliers.

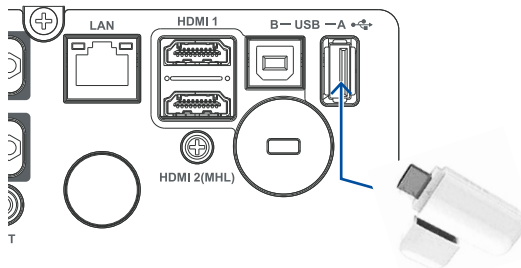

2. Please find "NetworkDisplay" during WLAN in Setting menu and click "Connect" to connect the WIFI.

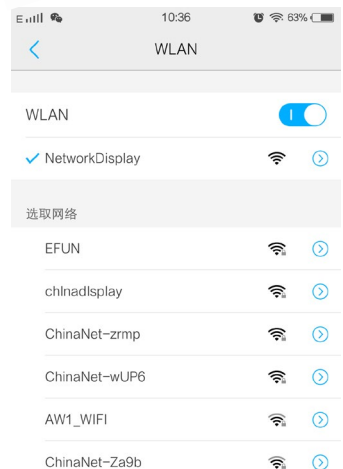

Network control

Installation procedure:

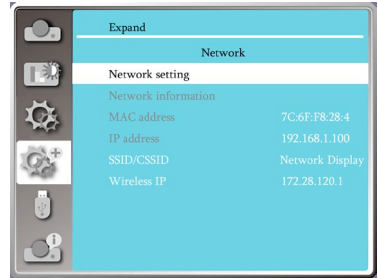

1) Type the Wireless address (<https://www.pixelworks.com/?q=node/19>) of the projector in the address bar of the web browser.

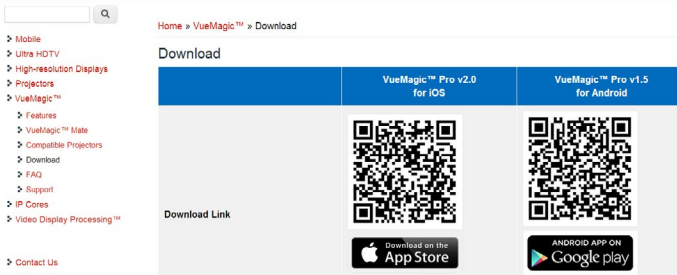

2) Click Download button.

3) VueMagic Software: Choose to download the appropriate VueMagic software system based on the mobile device and install it.



4) Click  icon to enter VueMagic software, then select the appropriate screen display menu location, and click on the top left icon  of the mobile device can be projected image or a file.

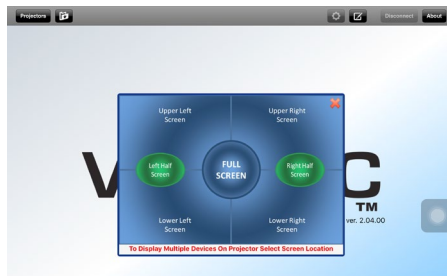

Click to enter to search, select the needed projector and connect it . Set the same IP address (for example: 172.28.120.1) as the projector in VueMagic software .

✓ NOTE

- Before using the pwPresenter search, please switch to the input signal of Network.

Wake On LAN control

- 1) Enter the Wireless address (For example: <https://wol.aquilatech.com/>), then enter to Wake On LAN official website.
 - Users can download the software at any other links.
- 2) Click "Download" button to download Wake On LAN software.

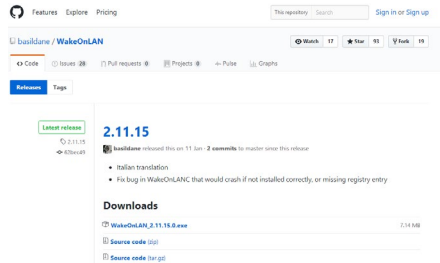

- 3) Click  icon for installation.

✓ **NOTE**

- Please select the wanted language to install.

Wake On LAN

Function: It is used for computer to remote wake-up of the projector.

Operation steps

- 1) Start the Wake On LAN software.
- 2) Click the "File" in the menu bar, then enter to the New Host.
- 3) Click the "Display Properties" in the menu bar, then enter the Name, Group and notes. Relevant pages just show as right.
 - Enter the Name and Group as you like. We take the Name of Sapphire plus and Group of EFUN for example
- 4) Click the "Wake Up" in the menu bar, then enter the MAC Address and FQDN / IP. Relevant pages just show as right.
 - For details on how to obtain the MAC Address, please refer to page P63.

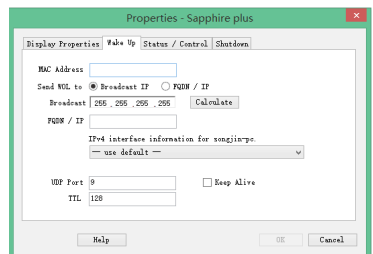
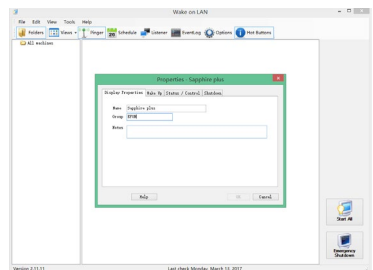

Network control

- 5 Click the "Status / Control" in the menu bar, then enter the Local IP Address. Relevant pages just show as right.
 - For details on how to obtain the Local IP Address, please refer to page P63.

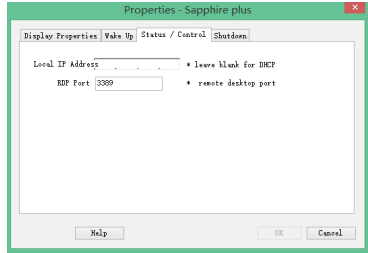

- 6 After the above steps are completed, then the group area will generate the corresponding icon. Right click on the icon, then click "wake up" to make waking.

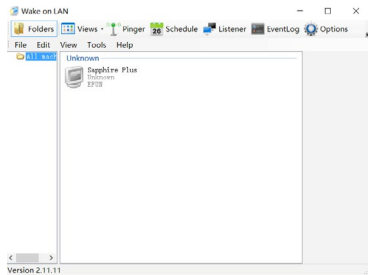

Note:

The downloading links provided in our user's manual is not the only links. Users can download it at anywhere you can.
The Wake On LAN software is not owned by our company.

Memory Viewer function

When the USB memory is inserted into the projector, the viewer memory function can project the video and pictures stored in the USB memory.

■ The projected content of Memory Viewer function

Memory Viewer function supports the following picture files.

Video	Extension name	Video Codec	Audio Codec	Video Format
	avi	MotionJPEG	ADPCM	Maximum 1280x720,30fps

	Extension name	Format	Description
Maps	jpg/jpeg	Baseline encoder 24 Progressive RGB24 bit	Max resolution: 10000x10000 Max resolution: Panel Resolution
	bmp	1,4,8 bit palette-based RGB24,32 bit	Max resolution: 1280x800
	png	24, 48-bit True Color	-24-Bit color palette space Max resolution: 1024x768
	gif	1,4,8-bit palette-based	Max resolution: 800x600
	tiff		Max resolution: 800x600

Display memory viewer screen

When the USB memory is inserted into the projector, the viewer memory function can project the video and pictures stored in the USB memory.

- 1) Press INPUT button on the control panel and on the top control panel and select the input source of [Memory Viewer].
- 2) Insert the USB memory into the <USB (browser) > terminal directly.
 - Press RC enter to display standby screen instantly, while the USB memory icon display in the left corner of the screen.
 - When the USB memory is independent of the partition, it will display more than one USB icon.
- 3) Press ▲▼ button to switch required items.
 - The root directory of the USB memory is displayed in a thumbnail.

Play image

Only one image shows on the screen when you play it.

- 1) Press ◀▶ button to select a file.
- 2) Press <OK or ▶ > button.
 - Full screen display
- 3) Press <OK > button.
 - Press <OK> to return the thumbnail.

Useful function

Play slide

The Slide Show Mode in the Memory Viewer menu is set to a special setting ,all images in the same folder can play automatically.





- 1) Press ◀▶ button to select a file.
- 2) Press ▲▼ button to select [Memory Viewer] menu,then select [From Scratch] menu.
- 3) Press <OK > button.
 - Full screen display
 - Press <OK> button to return the thumbnail.

Play video

Play video files.

- 1) Press ◀▶ button to select a file.
- 2) Press <OK> button.
 - Full screen display
 - Use the remote control to operate the controller that appears at the bottom of the screen.



	Stop playing the video and return to the thumbnail
	Play / pause the video
	Video fast backward / forward
	Video fast backward / forward at the twice speed
	Each time press the icon , the box switches . When the box appears, the video can playback.

The termination of Memory Viewer

The Slide Show Mode in the Memory Viewer menu is set to a special setting ,all images in the same folder can play automatically.

- 1) Press ◀▶ button to select  ,displayed in the left corner of the screen.
- 2) Press <OK > button.
 - Please Press RC ENTER to display standby screen instantly.
- 3) Unplug the USB memory directly.



Caution

- When you insert a USB memory, please make sure insertion direction to avoid damaging the port i.
- Please note the following points when inserting and removing USB memory:
 - a. The indicator flashes, when the USB memory insert into the projector or the projector is reading data. DO NOT remove the USB memory When the light is flashing.
 - b. If you use a USB memory device without lights, the projector will not recognize when reading data. Please close its browse function on and turn off the projector , then remove the USB memory.
 - c. Do not install and remove USB memory frequently. Then remove it after the installation of at least 5 seconds. After removing at least five seconds and then reinstall it. The projector is on switch mode during the operation, when installing or removing the USB memory.

Precautions on processing and storage of USB memory

- Please DO NOT place the USB memory or the lid where children can reach. Swallow USB memory or the lid may cause choking.
- If smoke or produce abnormal smell, close the external device and contact the dealer.
- DO NOT let the water, chemicals or oil into the USB memory, or it may cause a short circuit or fire.
- DO NOT put foreign matter or metal items in the USB port. Static electricity may cause data loss or data damage.
- When USB memory is read or written, DO NOT remove USB memory from the computer or projector , otherwise it may result in data loss or corruption of data.
- Please do not put the USB memory in high temperature, damp or dusty place, or next to magnetic materials.

NOTE

It allows the insertion or removal of the USB memory when the projector is in any power status.

USB display function

Select this function to can project the image and audio from the computer through the USB converter cable.

When using Windows :

■ Windows operating environment

Operating System	Vista Windows 32, 32/64 Windows7, Windows 8 32/64
CPU	Intel Core 2 Duo 2.0 GHZ or faster compatible processors
Memory Capacity	256MB or above (512MB or above)
Disk Space Available	20MB or above
Monitor	Resolution 640x480 or above, 1600x1200 or above

Useful function

CAN NOT guarantee that the PC meeting the above conditions can operate normally .

Project USB display

- 1) Using USB-B cable to connect the projector to the USB display terminals.
 - Items in grey are not available.
- 2) Press the information source menu on the remote control the INPUT button on the control panel, then select [USB display] in the input source menu.
- 3) Press the driver icon in the computer drive in the computer's task bar , the select one item in the pop-up menu bar.
 - Pop-up menu only display in English.

[Active audio] / [Disable audio]	Sets up the output from the computer's audio.
[Play video] / [Pause video]	Switch on playing and pausing images.
[Start / Stop]	Sets up the output from the computer's image.
[Exit]	Gray means not optional



NOTE

- Resolution of the computer screen will be switched.
- If the drive is not installed on the computer, the driver will be removed when the USB cable is disconnected .
- You need wait for a moment,if you want project computer screen.
- Connect the USB cable directly to the computer's USB connector. When connecting the USB hub, it may be abnormal.

The termination of USB display

- 1) Remove the USB cable directly,when terminate USB monitor.
 - You never need follow "Remove Hardware Safely, when USB cable is not connected.

When using Mac OS

■ Mac OS operating environment

Operating System	Mac os x 10.5,10.6,10.7
CPU	Power PC G4 1GHz or faster compatible processors
Memory Capacity	512MB or above
Disk Space Available	20MB or above
Monitor	Resolution 640x480 or above, 1600x1200 or above

CAN NOT guarantee that the PC meeting the above conditions can operate normally .

Project USB display

- Using USB-B cable to connect the projector to the USB display terminals.
 - Items in grey are not available.
- Press the information source menu on the remote controlor the INPUT button on the control panel, then select [USB Monitor] in the input source menu.
- Double-click "Monitor.app" button installed on the virtual disk.
 - Projecte image on the computer screen.
- Press the driver icon in the computer drive in the computer's task bar  ,the select one item in the pop-up menu bar.
 - Pop-up menu only display in Chinese.

[Active audio] / [Disable audio]	Sets up the output from the computer's audio.
[Play video] / [Pause video]	Switch on playing and pausing images.
[Start / Stop]	Sets up the output from the computer's image.
[Exit]	Terminate USB Monitor



NOTE

- Resolution of the computer screen will be switched.
- You need wait for a moment,if you want project computer screen.
- Connect the USB cable directly to the computer's USB connector. When connecting the USB hub, it may be abnormal.

The termination of USB display

- Remove the USB cable directly,when terminate USB display.

Maintenance and cleaning

Status light indicator

The status light indicator shows status of projector protection function. Check status and POWER light indicator for good maintenance operation.



Note:

Unplug the AC power cord in case of any abnormality as it may lead to fire or electric shock.

The projector turns off and the status light indicator flashes red.

Your projector powers off automatically to protect components within it when it is overheated. The POWER indicator flashes when your projector is cooling down. Press the STANDBY button to power your projector on again when it is cooled down to normal operation temperature.

FILTER STATUS POWER

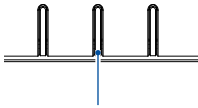

The status indicator flashing red

✓ **Note:**

The POWER indicator stops flashing when your projector's internal temperature cooled down to normal and it is powered on again.

Check the following:

- Is adequate clearance provided for your projector's ventilation? Check the installation status and any air outlet block.
- Is your projector installed at location close to outlet of air conditioning equipment? Keep your projector away from air outlet of air conditioning equipment.
- Is the filter in clean condition? Please clean the filter regularly.

Your projector powers off and the status light indicator turns red.

The STATUS indicator turns red and your projector powers off to protect its internal components whenever an abnormality is detected. Unplug the AC power cord and connect again. Restart your projector and run checkup routine. If the problem persists, unplug the AC power cord and call your service center for checkup and maintenance.

FILTER STATUS POWER

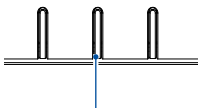

The status indicator turns red

Clean the projector when contaminated by foreign matter or its display effects are getting worse.



Note:

Unplug the AC power cord before any cleaning operation.

Clean casing of your projector

Wipe the casing surface with clean and soft cloth. Gently wipe the casing with clean and soft cloth dampened with small amount of neutral detergent to remove heavy dirt. Do not over apply cleaner to the casing. Abrasive cleaner, solution, or other rough chemical may scratch the casing surface.

Place your projector in proper container after use to protect it from dirt and dust and being scratched.

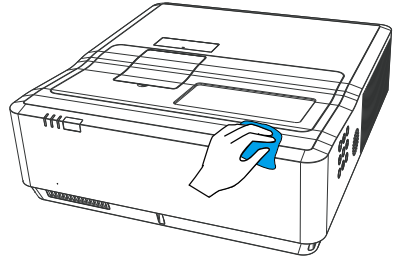

Clear the filter

The filter is designed to keep dust from entering in your projector, which may lead to dusts accumulated on surface of internal components. Clogged filter may reduce cooling fan effects, which, in turn, will overheat your projector and shorten its life cycle. Clean the filter immediately whenever the Filter Warning icon displays.

Please follow these steps to clean your filter:

- 1 Power off your projector and unplug from AC power source.
- 2 Remove the filter.
- 3 Gently clean it with a brush.
- 4 Replace the filter. Make sure it has been fully inserted.

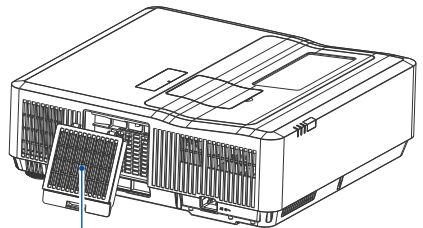

Filter counter



Note:

Do not operate your projector after its filter is removed. Dust may attach to the lens assembly and deteriorate image quality.

Do not insert any small object in the air outlet. It may fail your projector.

Maintenance and cleaning

Reset the filter counter

- 1 Press MENU button and the OSD displays. Press ◀▶ button to select Expand menu, press ▶ button or OK.
- 2 Press ▲▼ button to select "Filter Counter", press ▶ button or OK. Press ▲▼ button to select "Reset the filter counter" and press OK. The "Reset filter counter?" message displays. Select Yes to proceed.
- 3 In another pop-up dialog box, select Yes to reset the filter counter.

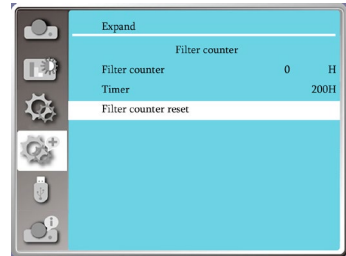

■ Recommendations

Please do not use your projector at place of dust and smoke. This may affects image quality. Using your projector in place of dust and smoke may lead to piling dusts on lens, LCD panel, and lens components within it. In case like this, call your dealer or service center for correct cleaning.



Note:

Reset the filter counter after its cleaning or replacement.

Troubleshooting

Check the following before calling your dealer or service center:

Troubleshooting	Solution
Power on failure	<ul style="list-style-type: none"> – Plug the power cord of your projector in an AC socket. – Make sure the POWER light indicator turns red. – Restart your projector until the POWER light indicator turns red. It indicates your projector is ready for power on again. – Disable the Key Lock function of your projector.
Logo screen display failure	<ul style="list-style-type: none"> – Make sure the Off and Countdown Off is selected in the Display function.
The Logo screen differs from the standard settings.	<ul style="list-style-type: none"> – Make sure you did not select User or Off in the Logo Screen.
Input signal switch (or do not switch) automatically.	<ul style="list-style-type: none"> – Make sure you have correctly set up the Input Search function.
Press INPUT button during power on and a non-input mode icon displays.	<ul style="list-style-type: none"> – This is a filter or light source replacement alerts.
A non-input or lamp mode icon displays.	<ul style="list-style-type: none"> – This is a filter replacement alerts.
Image looks fuzzy	<ul style="list-style-type: none"> – Adjust focus of your projector. – Provide proper projection distance. – The projection lens requires cleaning. – Moving your projector from a colder environment to a hotter one may result in condensing on the lens. If this is the case, wait until the condensing water evaporated before powering on your projector.
Image mirror reflected Image turns upside down	<ul style="list-style-type: none"> – Check the Ceiling and Rear settings. – Check the Ceiling settings.
Image looks dim	<ul style="list-style-type: none"> – Check for contrast and brightness settings. – Check for correct image mode settings
No image displays	<ul style="list-style-type: none"> – Check for the connection between your projector and computer or image equipment. – Check for correct input signal from computer. Connection with certain notebook computer may mandate changes to its display output settings. See the user manual included with the computer for details on settings. – It takes about 10 seconds for your projector to show the first image. – Check for mode of signal, color system, image system, or computer system. – Make sure the ambient temperature is within given range [0°C–40°C(35-ECO)]. – Image does not display in BLANK mode. The BLANK button or other buttons on the remote controller.

Appendix

Abnormal color	<ul style="list-style-type: none">– Check for mode of signal, color system, image system, or computer system.– Make sure Blackboard mode is not selected in Image Select.
Some operations are invisible	<ul style="list-style-type: none">– Check the display function.
Auto PC Adjusting function failure	<ul style="list-style-type: none">– Check input signal. Auto PC Adjusting function is unavailable in 480p, 576p, 720p, 480i, 576i or 1080i mode.
Settings do not save after power off	<ul style="list-style-type: none">– Make sure you have selected Store after settings adjustment. Certain settings do not keep without selecting Store.
Power management failure	<ul style="list-style-type: none">– In case of Freeze or Blank operation, the power management function does not work.
Auto Setting does not work	<ul style="list-style-type: none">– Make sure it is not set to "Off" in each setup menu.– Make sure "On" is not set in Ceiling function.
Image distorted or disappeared	<ul style="list-style-type: none">– Check and revise the PC Adj. menu or Screen menu.
A password prompt displays after power on	<ul style="list-style-type: none">– You have set up the Logo PIN Code lock function
Remote controller does not work	<ul style="list-style-type: none">– Check the battery.– Make sure there is no obstacles stand in between your projector and the remote controller.– Make sure the remote controller is not too far away from your projector. The maximum operation range is 8m.– Make sure the remote controller and your projector are paired with the same remote control codes.– Disable the key lock of the remote controller in the Setup menu.
Light indicator turns on or flashes	<ul style="list-style-type: none">– Check status of your projector according to the light indicator status.
"X " mark displays	<ul style="list-style-type: none">– Invalid operation, please operate your projector correctly.
Control panel does not function	<ul style="list-style-type: none">– Disable the key lock on control panel function in the Safety option of the Setup menu.
Cannot remove the Logo Select password, Key Lock, and PIN Code lock	<ul style="list-style-type: none">– Please call your dealer or service center.

- Make sure your projector is correctly connected to external equipment.
- Make sure all devices have plugged in an AC power source and have been powered on.
- If your projector fails to project image of the connected computer, restart the computer.

**Note:**

Your projector employs high voltage power for operation. Do not open its casing. If the problem persists, call your dealer or service center. Along with model number of your projector and a description to your problem. You will be advised on getting our services.

Menu tree

Main menu	Sub-menu	Setting	Remarks
Display	Auto PC adj.		
	Fine sync	0-31	
	H Position	-5 - +5	
	V Position	-5 - +5	
	H Size	-15 - +15	The range of H Size differs from signals.
	Aspect	Normal Wide Full	
	Project way	Front Rear Ceiling / Front Ceiling / Rear Auto ceiling / Front Auto ceiling / Rear	
	Menu position	Upper Left, Upper Right Center Lower Left, Lower Right	
	Background display	Black Blue	
	System	Auto PAL SECAM NTSC NTSC4.43 PAL-M PAL-N PAL-60	S-Video Input Video Input
Color adj.	Image mode	Dynamic Standard Cinema DICOM Blackboard (Green) Colorboard User Image	
	Contrast	0-63	PC Input
	Brightness	0-63	
	Color temp	High/Mid/Low	
	Red	0-63	
	Green	0-63	
	Blue	0-63	
Sharpness	0-15		

Appendix

Main menu	Sub-menu	Setting	Remarks	
Color adj.	Contrast	0-63	Component Input S-Video Input Video Input	
	Brightness	0-63		
	Color	0-63		
	Tint	0-63		
	Red	0-63		
	Green	0-63		
	Blue	0-63		
	Sharpness	0-15		
Setting	On start	On/Off		
	Standby Mode	Normal/ECO mode		
	High land	On/Off		
	Light source control	Normal/ECO mode		
	Cooling fast	Normal/30s /0s		
	Closed caption	Off/CC1/CC2/CC3/CC4		
	Key lock	Off/Projector/Remote controller		
	Contrast optimization	On/Off		
	Sound	Volume	0-25	
		Mute	On/Off	
	HDMI Setup	Image	64-940	
0-1023				
Volume		HDMI PC		
Expand	Language	Projector provides multiple language support		
	Auto Setup	Input Search	On/Off	
		Auto PC Adj.	On/Off	
	Keystone	Keystone	Store / Reset	
		H/V Keystone		
		Corner correction		
		Curved correction		Citrine WUXGA do not support
	Reset value			
	Security	PIN code lock	On/Off	
		PIN code change		
	Logo	Logo select		
Capture		Citrine WUXGA do not support		
Logo PIN Code Lock				
Logo PIN Code Change				

Main menu	Sub-menu	Setting	Remarks	
	Power management	Ready power Off Off Timer Ready Countdown		
	Filter counter	Filter counter Timer Filter counter reset		
	Text pattern	Off, Gray scale (1-4), Color bar, Red, Green, Blue, Cross hatch , White, Black, Raster gray		
	Network	Network setting	LAN DHCP(On/Off) IP address Subnet Gateway DNS	
		Network status	MAC address IPaddress	
	Factory default			
Memory Viewer	Set slide			
	Slide transition effect	Slide down Slide right		
	Sort order	Expand name orde Magnitude order Time orde Name order		
	Sort order	No rotate 270° rotate 180° rotate 90°rotate		
	Best fit	On/Off		
	Repeat	On/Off		
	Apply			
Info.	H- sync. Freq.			
	V- sync. Freq.			
	Light source status			
	Light source counter			
	Power management			
	Image mode			

































Input:

VGA 1, VGA 2*, HDMI, HDMI2 (MHL), Component, Video, S-Video, Network, Memory Viewer and USB Display

Appendix

Light indicator status

Check light indicator to learn status of your projector.

Light indicator			Status of your projector
POWER Green /Red	STATUS	FILTER	
			Your projector is in Off status (without AC power supply).
			Your projector is in standby status. Press Standby button to turn it on.
			Your projector is in normal status.
			It is ready for standby or the lamp is cooling. You may power on your projector only after the lamp is fully cooled and the POWER light indicator stops flashing.
			Your projector is in Ready mode.
			Your projector detects abnormal situation and cannot power on. Unplug the AC power cord and connect it again before powering on your projector. If it powers off again, please unplug the cord and call your dealer or service center for maintenance or inspection. Do not let it continue operating as this may lead to electric shock or fire.
			Your projector detects lamp abnormality and cools down.
			Your projector detects lamp abnormality and switches into standby mode.
			Your projector cannot power on, as its internal temperature is too high. You may power it on after it is fully cooled, temperature backs to normal, and the POWER light indicator turns red.
			You may power is fully cooled with temperature backs to normal.
			The filter requires cleaning

 ... Green

 ... Red

 ... Yellow

 ... Turns off

 ... Flashing green

 ... Flashing red

 ... Flashing yellow

Compatible computer screen

Your projector is designed to accept every computer signal below Dot Clock 160MHz .
See table below for details on resolution and relevant frequency.

No	OSD Display	Source				Specification			
		RGB	Component	HDMI	Video/ S-Video	Resolution	H-freq(KHz)	V-freq(Hz)	Pixel clock (MHz)
1	NTSC	—	—	—	○	NTSC	15.734	59.940	—
	NTSC-443	—	—	—	○	NTSC 4.43			
	PAL-60	—	—	—	○	PAL60			
	PAL-M	—	—	—	○	PAL-M			
2	PAL	—	—	—	○	PAL	15.625	50.000	—
	PAL-N	—	—	—	○	PAL-N			
	SECAM	—	—	—	○	SECAM			
3	720x480i 60Hz	○	○	—	—	720x480i	15.734	59.940	13.500
4	720x480i 60Hz	—	—	○	—	720 (1440) x480i	15.734	59.940	27.000
5	720x576i 50Hz	○	○	—	—	720x576i	15.625	50.000	13.500
6	720x576i 50Hz	—	—	○	—	720 (1440) x576i	15.625	50.000	27.000
7	720x483 60Hz	○	○	○	—	720x483(480P)	31.469	59.940	27.000
8	720x576 50Hz	○	○	○	—	720x576(576P)	31.250	50.000	27.000
9	1280x720p 60Hz	○	○	○	—	1280x720p	45.000	60.000	74.250
							44.955	59.940	74.176
							37.500	50.000	74.250
10	1280x720p 50Hz	○	○	○	—	1280x720p	33.750	60.000	74.250
							33.716	59.940	74.176
11	1920x1080i 60Hz	○	○	○	—	1920x1080i	28.125	50.000	74.250
12	1920x1080i 50Hz	○	○	○	—		27.000	24.000	74.250
13	1920x1080p 24Hz	—	—	○	—	1920x1080p	26.970	23.980	74.176
							67.500	60.000	148.500
14	1920x1080p 60Hz	○	○	○	—	1920x1080p	67.433	59.940	148.352
15	1920x1080p 50Hz	○	○	○	—		56.250	50.000	148.500
16	640x480.60Hz	○	—	○	—	640x480	31.469	59.940	25.175
17	640x480.67Hz	○	—	○	—		35.000	66.667	30.240
18	640x480.72Hz	○	—	○	—	640x480	37.961	72.809	31.500
19	640x480.75Hz	○	—	○	—		37.500	75.000	31.500
20	640x480.85Hz	○	—	○	—	640x480	43.269	85.008	36.000
21	800x600.56Hz	○	—	○	—		35.156	56.250	36.000
22	800x600.60Hz	○	—	○	—	800x600	37.879	60.317	40.000
23	800x600.72Hz	○	—	○	—		48.077	72.188	50.000
24	800x600.75Hz	○	—	○	—	800x600	46.875	75.000	49.500
25	800x600.85Hz	○	—	○	—		53.674	85.061	56.250
26	832x624.75Hz	○	—	○	—	832x624	49.725	74.550	57.283
27	1024x768.60Hz	○	—	○	—		48.363	60.004	65.000
28	1024x768.70Hz	○	—	○	—	1024x768	56.476	70.069	75.000
29	1024x768.75Hz	○	—	○	—		60.023	75.029	78.750
30	1024x768.85Hz	○	—	○	—	1024x768	68.678	84.997	94.500
31	1152x864.70Hz	○	—	○	—		63.995	70.020	94.200
32	1152x864.75Hz	○	—	○	—	1152x864	67.500	75.000	108.000
33	1280x720.60Hz	○	—	○	—		1280x720	44.772	59.855
34	1280x768.60Hz	○	—	○	—	1280x768	47.776	59.870	79.500
35	1280x768.75Hz	○	—	○	—		60.289	74.893	102.250
36	1280x768.85Hz	○	—	○	—	1280x768	68.630	84.840	117.500
37	1280x800.60Hz	○	—	○	—		49.702	59.810	83.500
38	1280x800.75Hz	○	—	○	—	1280x800	62.795	74.934	106.500
39	1280x800.85Hz	○	—	○	—		71.554	84.880	122.500
40	1280x960.60Hz	○	—	○	—	1280x960	60.000	60.000	108.000
41	1280x1024.60Hz	○	—	○	—		63.981	60.020	108.000
42	1280x1024.72Hz	○	—	○	—	1280x1024	78.16	71.97	135.060
43	1280x1024.75Hz	○	—	○	—		79.976	75.025	135.000
44	1280x1024.85Hz	○	—	○	—	1280x1024	91.146	85.024	157.500
45	1366x768.60Hz	○	—	○	—		1366x768	47.720	59.799
46	1400x1050.60Hz	○	—	○	—	1400x1050	65.317	59.978	121.750
47	1400x1050.75Hz	○	—	○	—		82.278	74.867	156.000
48	1440x900.60Hz	○	—	○	—	1440x900	55.935	59.887	106.500
49	1600x900.60Hz	○	—	○	—		55.920	60.000	118.998
50	1600x1200.60Hz	○	—	○	—	1600x1200	75.000	60.000	162.000
51	1680x1050.60Hz	○	—	○	—		65.290	59.954	146.250
52	1920x1080.60Hz	○	—	○	—	1920x1080	66.587	59.934	138.500
53	1920x1200.60Hz	○	—	○	—		74.038	59.950	154.000

“○” shows input signal source support this format ; “—” shows input signal source DONOT support.

✓ Note:

Changes to this manual may be made without notice.

Appendix

Terminal configuration

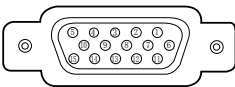
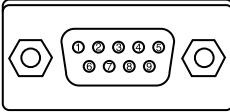
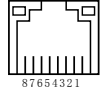
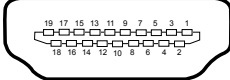
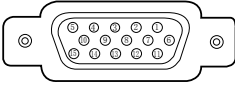
VGA IN / MONITOR OUT Terminal (D-sub 15)				
	1	Red (Input/output)	9	----
	2	Green(Input/output)	10	Grounding(field synchronizing)
	3	Blue(Input/output)	11	Grounding
	4	----	12	DDC data
	5	Grounding (line synchronizing)	13	Horizontal synchronizing(compound sync.) input/output
	6	Grounding(red)	14	Vertial synchronizing input/output
	7	Grounding(green)	15	DDC Clock
	8	Grounding(blue)		
RS232 Terminal(D-SUB 9)				
	1	----	6	----
	2	RXD	7	----
	3	TXD	8	----
	4	----	9	----
	5	GND		
LAN Terminal				
 <p>87654321</p>	1	TX +	5	----
	2	TX -	6	RX -
	3	RX +	7	----
	4	----	8	----
HDMI Terminal (HDMI Type A 19)				
	1	TMDS Data2+	11	TMDS Clock Shield
	2	TMDS Date2 Shield	12	TMDS Clock-
	3	TMDS Date2-	13	CEC
	4	TMDS Date1+	14	Reserved(N.C. on device)
	5	TMDS Date1 Shield	15	SCL
	6	TMDS Date1-	16	SDA
	7	TMDS Date0+	17	DDC/CEC Ground
	8	TMDS Date0 Shield	18	+5V Power
	9	TMDS Date0-	19	Hot Plug Detect
	10	TMDS Clock+		
VGA IN 1 Terminal				
	1	Red/Pr/S-C input	9	----
	2	Green/Y/S-Y input	10	Grounding(field synchronizing)
	3	B/Pb/- input	11	Grounding
	4	----	12	DDC data
	5	Grounding(line synchronizing)	13	Horizontal synchronizing (compound sync.)input
	6	Grounding(red)	14	Vertial synchronizing input
	7	Grounding(green)	15	DDC clock
	8	Grounding(blue)		

Dimensions

↘ Unit: mm
 Screw Holes for Ceiling Mount
 Screw: M4
 Depth: 10.0

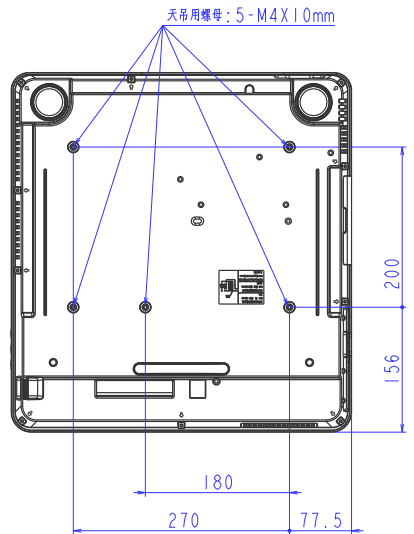
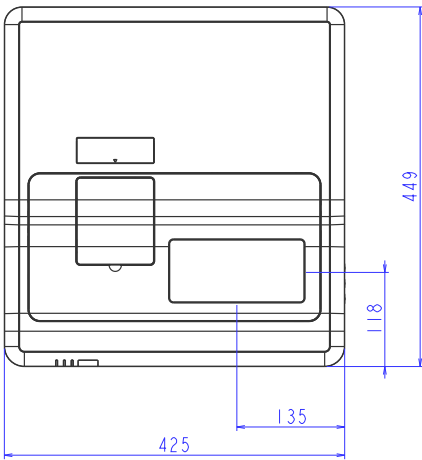
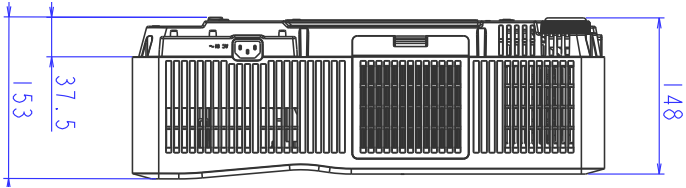

Appendix

Technical Specifications

Mechanical properties

Dimensions (W×H×D):	447mm x 425mm x 153mm
Net Weight	11.0Kg
Adjustable foot	4°

LCD resolution

LCD system	0.79"/0.76"/0.76" TFT, active matrix
LCD resolution	1024x768/1280x800/1920x1200

Compatible signals

Color standard	PAL, SECAM, NTSC, NTSC4.43, PAL-M and PAL-N, PAL-60
HDTV signal	PAL, SECAM, NTSC 4.43, PAL-M, PAL-N, PAL-60, 480i, 480p, 576i, 576p, 720p, 1080p, 1080i

Scanning frequency Horizontal frequency: 15 kHz–100 KHz; Vertical frequency: 48–85 Hz

Optical elements

Image size (diagonal lines)	XGA(75"-138"), WXGA/WUXGA(70"-130") adjustable
Projection distance	XGA:0.516m-0.908m WXGA:0.510m-0.903m WUXGA:0.510m-0.903m

Lens (Standard Lens) F=1.78-1.83, f=4.92-5.18mm
Manual zooming and focusing; Zoom times: 1.05
About 450W (ECO. < 0.5W)

Lamp power

Terminal

VGA IN 1	Mini D-sub 15pin x1
VGA IN 2	Mini D-sub 15pin x1
VGA OUT	Mini D-sub 15pin x1
HDMI	HDMI A type 19 pin
HDMI 2 (MHL)	HDMI A type 19 pin
LAN	100 Base-TX (100Mbps)/10 Base-T (10Mbps), RJ45
USB-B	USB connector (B type x1)
USB-A	USB connector (A type x1)
RS-232 terminal	D-sub 9 pin x1
AUDIO IN	Mini Stereo 3.5mm x1
AUDIO OUT	Mini Stereo 3.5mm x1
MONO(R/L)	RCA connector * 2
VIDEO	RCA connector * 1

Power

Voltage and power consumption	AC 100–240 V (Max5.5A), 50/60 Hz
Fuse	10A/250V
Internal speaker	10W RMS 8ohm, *2

Operating Environment

Operating temperature	0°C ~40°C (35~ ECO)
Storage Temperature	-20°C ~60°C
High land	2700 m

Remote control

Battery	AAA ALKALINE TYPE x 2(including batteries)
Operating Range	±15° about 6 m or about 8 m straight
Dimensions	110mm(L)X50mm(W)X20mm(H)
Net Weight	38g

Accessories

Remote control and batteries
AC power cord
VGA cable

- The aforesaid specification is subject to change without prior notice.
- Liquid crystal panel is made on the basis of high standard, where 99.99% of the pixels are effective. Due to the nature of the liquid crystal panel, a fraction of the pixels (0.01% or less) may be ineffective.

RS232 control mode

Serial connection

1.1 Port setting

Project	Setpoint
Communication method	Asynchronous communication
Communication rate	19200
Length	8-bit
Parity check	NO
Stop position	1
Flow control	NO

1.2 Connection mode

Can only use RS232 serial cross connect PC and projector.

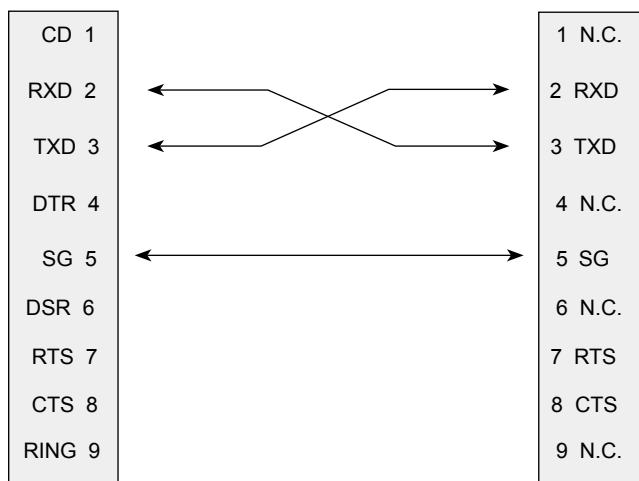
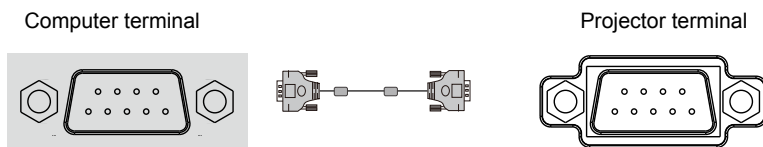

Appendix

2. Basic commands

Distinguish the letter case and enter Each command ends with [CR] (enter) .

Command	Option	Command	Option
C00	POWER ON	C07	Video
C01	POWER OFF(Immediately)	C33	Component
C02	POWER OFF	C34	S-Video
C36	HDMI1	C15	Network
C38	HDMI2 (MHL)	C16	Memory Viewer
C05	VGAIN 1	C17	USB Display
C06	VGAIN 2		

2.1 POWER ON command

Command	"C00" [CR]		
Details	Power ON action. Do nothing,when you are in Power ON state . Send this command can force the end of the countdown in the countdown state.		
Return Value	Receive Successfully	[ACK]	[CR]
	Receive Unsuccessfully	"? "	[CR]

2.2 POWER OFF command (Namely Power Off immediatly)

Command	"C01" [CR]		
Details	Power OFF action. Send this command can force your projector to power off during in power on state.		
Return Value	Receive Successfully	[ACK]	[CR]
	Receive Unsuccessfully	"? "	[CR]

2.3 POWER OFFcommand

Command	"C02" [CR]		
Details	Power OFF action. A "POWER OFF " dialog box pops up when sending the POWER OFF command ,and do once again can force your projector to power off. Send this command can force the end of the countdownthe in the countdown state.		
Return Value	Receive Successfully	[ACK]	[CR]
	Receive Unsuccessfully	" ? "	[CR]

2.4 HDMI 1 command

Command	"C36"[CR]	
Details	Select HDMI Input.	
Return Value	Receive Successfully	[ACK] [CR]
	Receive Unsuccessfully	"? " [CR]

2.5 VGA IN 1 command

Command	"C05" [CR]	
Details	Select VGAIN 1 Input	
Return Value	Receive Successfully	[ACK] [CR]
	Receive Unsuccessfully	"? " [CR]

2.6 VGA IN 2 command

Command	"C06" [CR]	
Details	Select VGAIN 2 Input	
Return Value	Receive Successfully	[ACK] [CR]
	Receive Unsuccessfully	"? " [CR]

2.7 S-Video command

Command	"C34"[CR]	
Details	Select S-Video Input .	
Return Value	Receive Successfully	[ACK] [CR]
	Receive Unsuccessfully	"? " [CR]

2.8 Component command

Command	"C33" [CR]	
Details	Select Component Input.	
Return Value	Receive Successfully	[ACK] [CR]
	Receive Unsuccessfully	"? " [CR]

Appendix

2.9 Network command

Command	"C15"[CR]	
Details	Select Network Input .	
Return Value	Receive Successfully	[ACK] [CR]
	Receive Unsuccessfully	"? " [CR]

2.10 Memory Viewer command

Command	"C16"[CR]	
Details	Select Memory Viewer Input .	
Return Value	Receive Successfully	[ACK] [CR]
	Receive Unsuccessfully	"? " [CR]

2.11 USB Display command

Command	"C17"[CR]	
Details	Select RGBHV Input	
Return Value	Receive Successfully	[ACK] [CR]
	Receive Unsuccessfully	"? " [CR]

2.12 Video command

Command	"C07"[CR]	
Details	Select Video Input	
Return Value	Receive Successfully	[ACK] [CR]
	Receive Unsuccessfully	"? " [CR]

2.4 HDMI 2 command

Command	"C38"[CR]	
Details	Select HDMI 2 Input.	
Return Value	Receive Successfully	[ACK] [CR]
	Receive Unsuccessfully	"? " [CR]

